

Kawasaki



H2-A

**Assembly &
Preparation Manual**

KAWASAKI MOTORS CORP. ● © 1972 PRINTED IN U.S.A.

1973

KAWASAKI MODEL H2-A ASSEMBLY AND PREPARATION MANUAL

There are three major sections in this manual:

- ASSEMBLY INSTRUCTIONS —Work performed during uncrating and assembly.
- PREPARATION SERVICING —Detailing and inspection performed before delivery.
- SERVICE SPECIFICATION —Handy specs for possible trouble-shooting.



ASSEMBLY INSTRUCTIONS

Clear a 20' x 20' area, and then position the crate upright on its base. Pry off the top panel, and then cut the banding wires at the corners of the crate.



Fold down the left side panel and pull down the two end panels. Remove the two cross braces on the top of the seat, and lift the small parts carton from behind the motorcycle. Peel off the plastic covering, but do not remove the protective packaging material from the fuel tank. Knock the cross braces loose from the right-hand panel of the crate. CAUTION: Peen over any nails to prevent injury or puncturing the tires.



Lift out the front wheel assembly, the two parts cartons, and the dual seat assembly, and remove the handlebar by prying loose the strap holding it to the base of the crate. With an assistant, move the motorcycle to the work area and park it on its center stand.

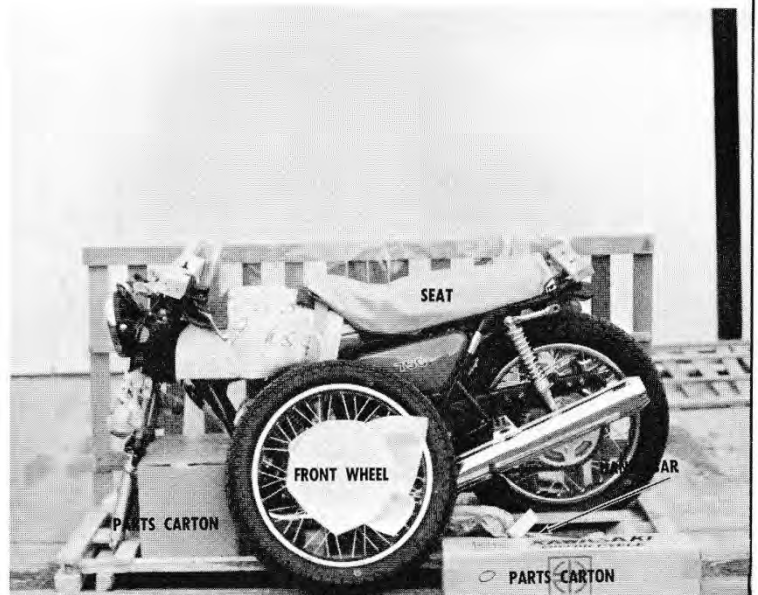



Open the parts carton and check the contents against this photo.

- A. Dual seat assembly
- B. Seat backrest hardware: 4 bolts, 4 lock-washers, 4 washers
- C. Seat backrest assembly
- D. Front fender
- E. Front wheel assembly
- F. Rear turn signal units
- G. Seat hinge pins with 2 safety clips
- H. Rear view mirror
- I. Tool kit
- J. Speedometer assembly
- K. Tachometer assembly
- L. Meter hardware: 8 washers, 4 nuts

- M. Front fender hardware: 4 bolts, 4 lock-washers
- N. Front axle with spacer, 2 clamp caps, 4 lock-washers, 4 nuts
- O. Speedometer drive gear box
- P. Turn signal hardware: 2 bolts, 2 cup washers, 2 ground springs, 2 grommet "A", 2 grommet "B", 2 lockwashers, 2 nuts
- Q. Handlebar assembly
- R. Rider's Handbook
- S. Steering damper assembly with 2 friction discs, torque plate, nut plate, spring, nut, and cotter pin
- T. Handlebar wiring strap

Turn the lower fork tubes so that the fender mounting holes face inward. Mount the front fender with four 16mm long bolts and lockwashers, with the short end of the fender toward the front. Be sure to mount the brake hose bracket between the fender brace and the lower fork leg, as shown. CAUTION: Do not bend the hydraulic brake pipe during this operation or it may cause the disc brake linings to squeal.



Check the inside of the speedometer drive gear assembly for loose parts and fit it to the front wheel hub. Be sure to align the tangs in the drive assembly to the recesses in the hub. CAUTION: Loose parts can wedge into the speedometer drive gears with resulting damage.



Insert the axle spacer into the hub grease seal, as shown, and thread in the axle.



Tighten the axle securely. Then turn the speedometer drive assembly to check for binding.



Wipe the disc clean with trichloroethylene or other oilless solvent.



Remove the cardboard spacer from between the caliper pads. Lift the front wheel into position with the disc between the caliper pads, and the axle ends between the axle mounting studs.



Fit the axle mounting caps with nuts and lockwashers, but do not tighten them yet.

NOTE: The nuts are finished on one side only. The flat side must face the lockwasher. Turn the speedometer drive assembly so that the cable axis points toward the left exhaust pipe flange nut. This will insure that there are no sharp bends in the lower end of the speedometer cable.

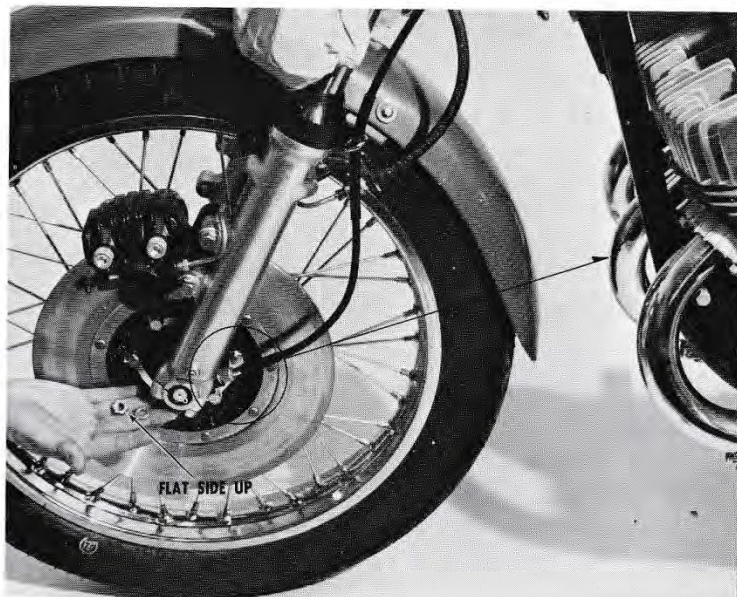

Tighten the axle mounting caps securely. Take care to keep the gaps equal, as shown.



Remove the bolt holding the brake master cylinder to the bracket on the cross brace. This can best be done by inserting a bar in the master cylinder handlebar clamp, as shown, while turning the bolt. Remove the nut and washer holding the cross brace to the steering stem head. Discard the cross brace.



Remove the four handlebar clamp bolts and lockwashers, and discard the plate and hold-down bolt. Temporarily, reinsert the handlebar clamp bolts with lockwashers.

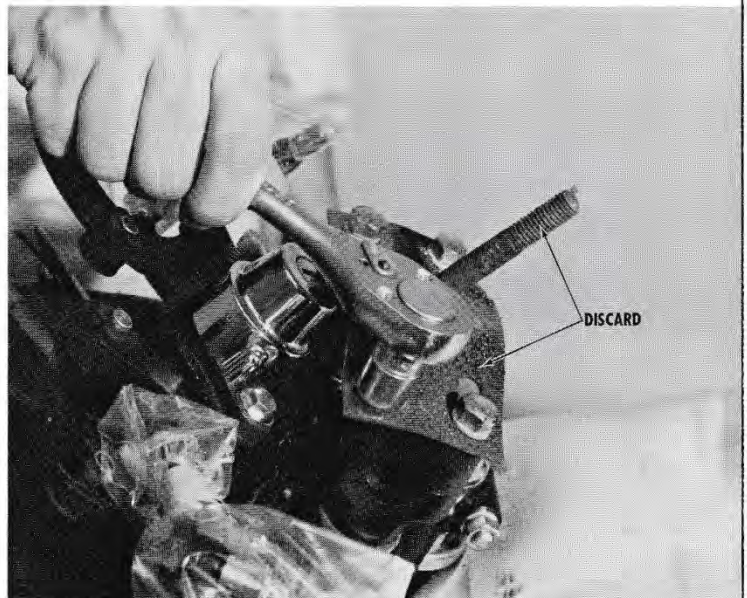

To mount the speedometer and tachometer, first plug in the instrument lights as shown in the diagram.

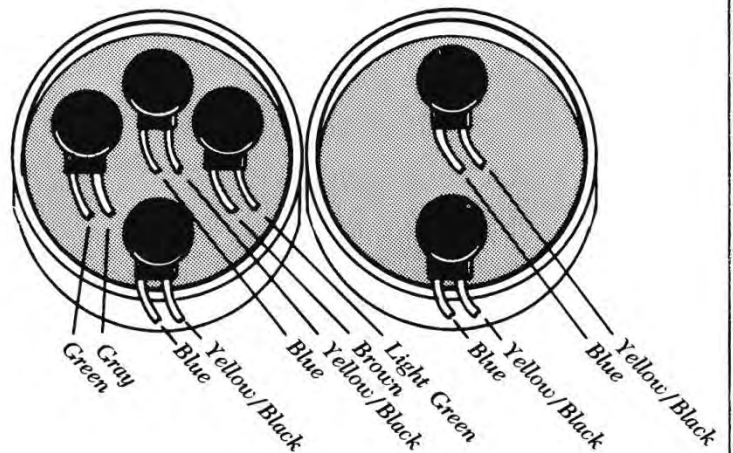

Fit the thick metal washers to the mounting studs, and slip the studs through the metal sleeved grommets in the instrument mounting bracket.

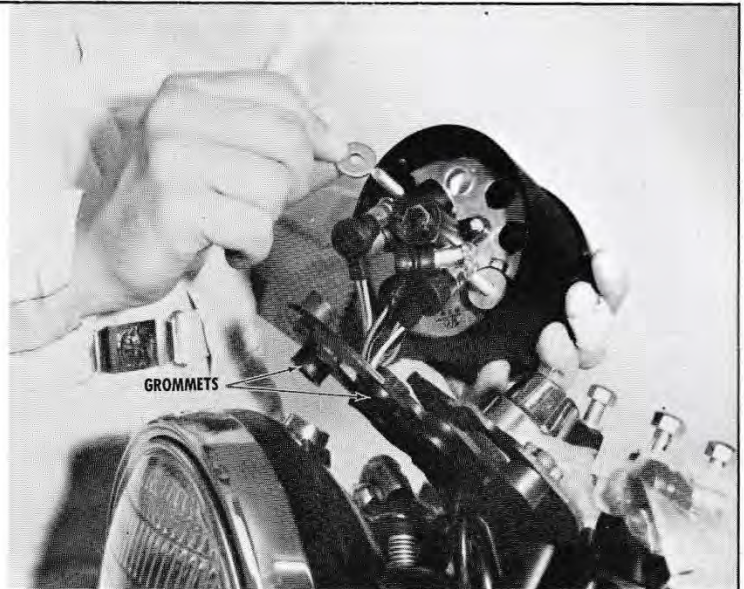

Check to be sure that the rubber lens shade at the top of the meter fits into the metal housing all around. Fit a thin washer and an acorn nut to each stud and tighten them securely.

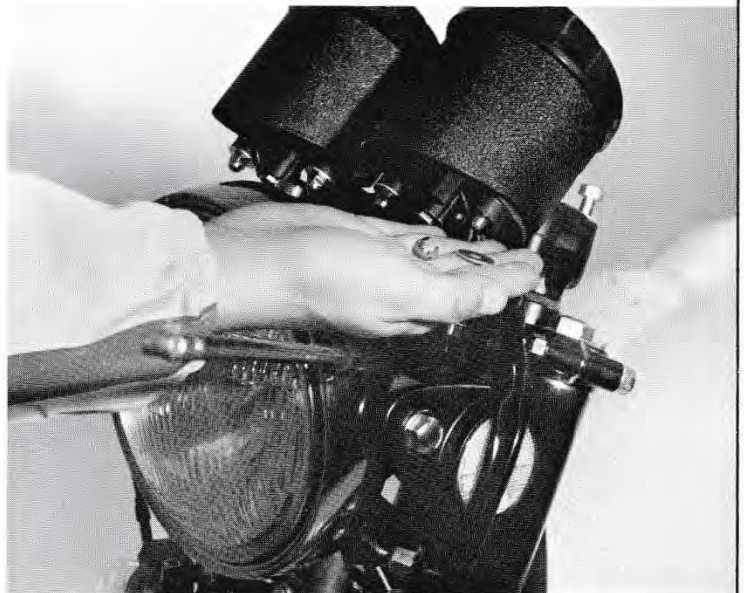

Route the speedometer cable through the bracket on the lower fork tube, through the loop on the lower triple clamp, inside the headlight bracket, and into the cable socket. Spin the front wheel slowly to ease the insertion of the cable into the socket. Slip the tachometer cable into its socket, and tighten both ring nuts securely.

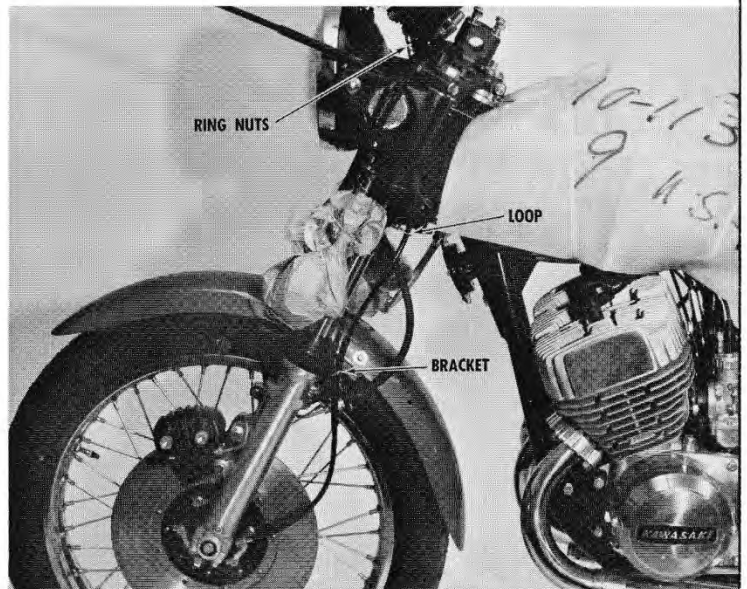

Remove the handlebar clamp bolts and check the handlebar holders for bent studs. Position the handlebar in the holders, as shown, and install the two clamps with four bolts and lockwashers, but do not tighten them yet. Slide the twist grip assembly onto the handlebar, taking care to center the starter lever. Rotate the handlebar to the proper position and tighten the clamps. Tighten the two Phillips head screws in the throttle case so that the cables are pointing downward. Be sure that the rubber hand grip does not drag on the end of the handlebar.



Mount the brake master cylinder next to the twistgrip. The nipple on the side of the handlebar clamp cap is to space the master cylinder assembly the proper distance from the twistgrip. Tighten the bolts to about 4.5 lb.-ft. of torque.

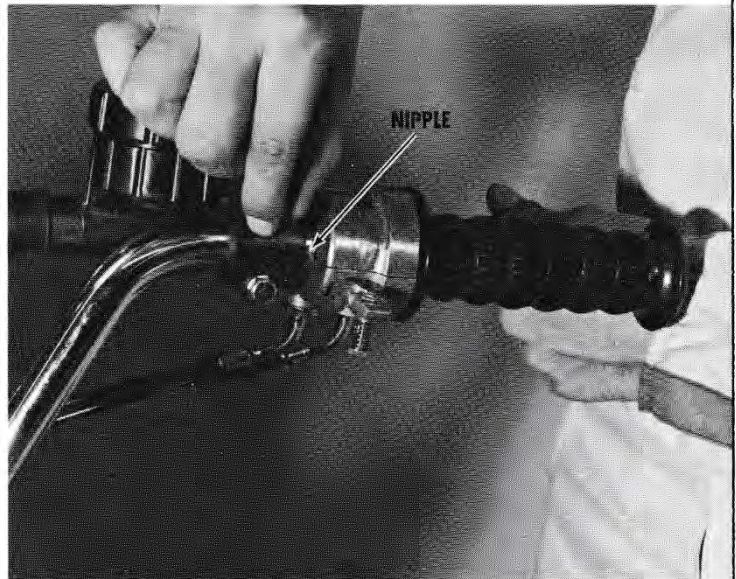

Turn the adjuster and thumbwheel into the lever holder as far as possible and then back them out until the slots line up. Push the cable nipple up into the lever socket. Pull on the cable sheath, and then swing the cable into the adjuster and release it.

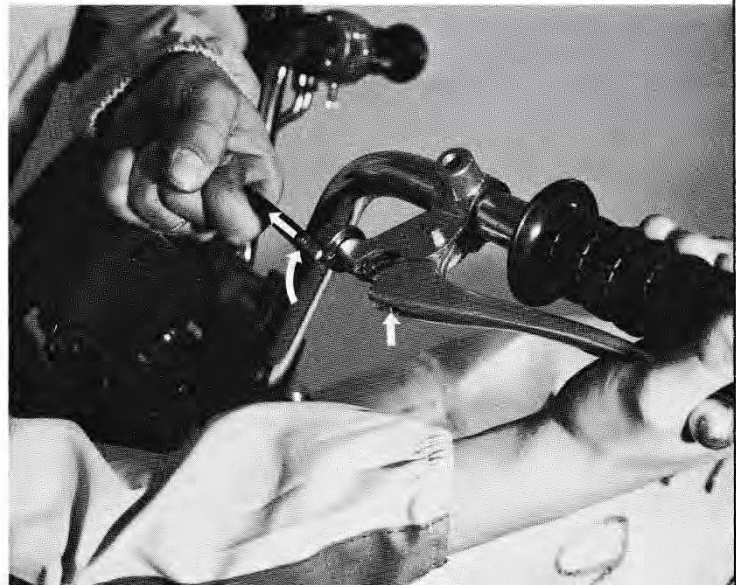

Mount the left-hand grip case with the wiring harness on the bottom and tighten the two Phillips head screws. Fit the two handlebar wiring straps, as shown.

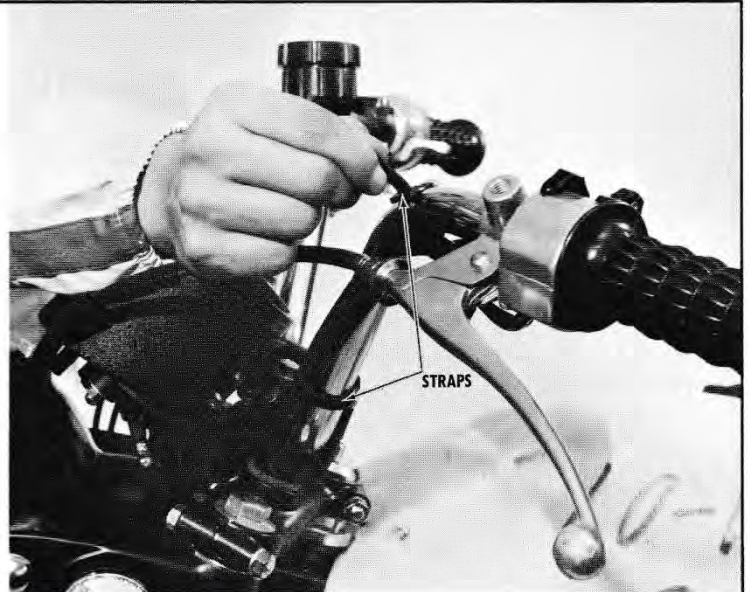

Mount the rear view mirror on the clutch lever holder. Tighten the locknut when the mirror is in the proper position, and strip off the protective plastic backing. Insert the plug in the other mirror mounting hole. Finally, remove the protective packaging material from the fuel tank.

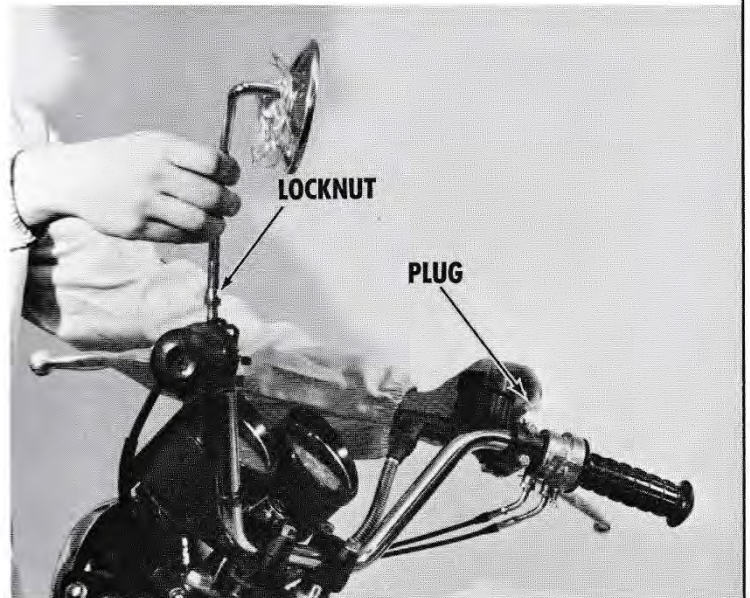

Mount the knob detent spring and thread on the detent nut. Position the knob detent spring with the tongue to the front. Tighten the detent nut and insert the damper shaft into the steering stem.



Stack the steering damper parts, as shown here, before installation. CAUTION: Clean off any oil or grease with an oilless solvent, such as trichloroethylene, to insure smooth damper action. Follow these assembly instructions exactly to prevent steering difficulties.

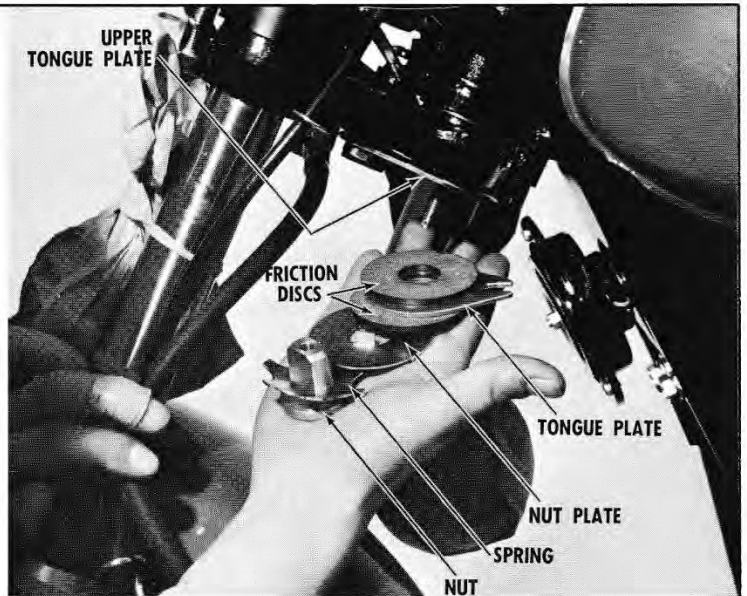

The upper tongue plate is bolted to the lower triple clamp at the factory. Install the parts shown in the previous step, taking care to engage the tongue plate with the frame stud. Screw the nut, with spring, onto the damper shaft. Finally, insert the safety cotter pin and split the ends.



Mount the front turn signals. All the necessary hardware is already "strung" on the turn signal lamp wire in the proper order of assembly. Be sure the face of the lens is vertical during the final tightening.



Mount the rear turn signals. Be sure all the parts shown here are installed in the order shown. NOTE: The ground clip must be fitted to grommet "A" or the lamp will not light.

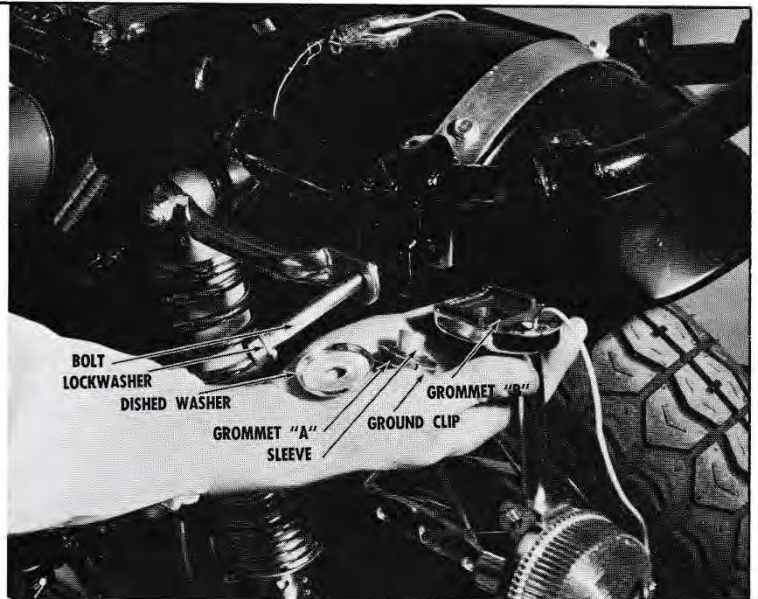

Tighten the bolt securely, and plug the wire from the left turn signal lamp into the green lead, and the wire from the right turn signal lamp into the gray lead.

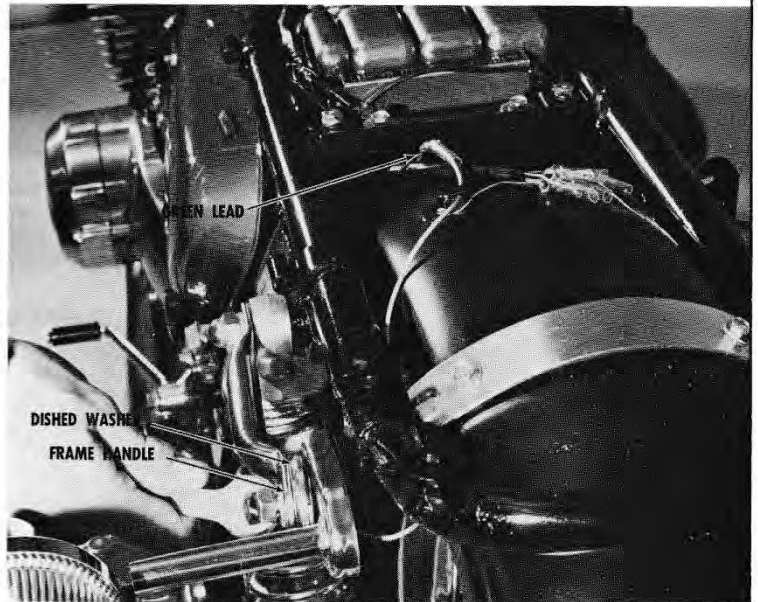

Position the dust panel in the seat backrest and route the taillight wiring harness through the extra notch and under the panel.

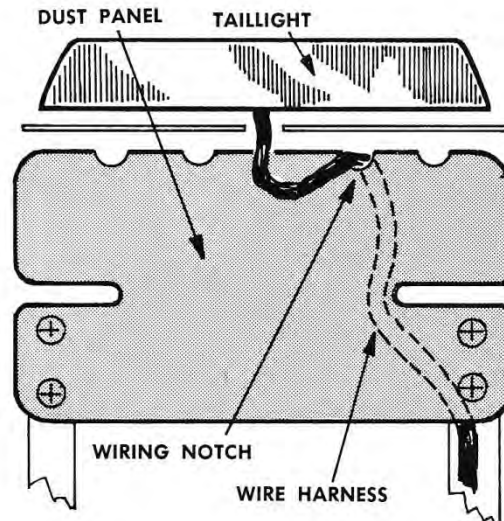

Mount the seat backrest with the four bolts and lockwashers so that the dust panel is under the backrest brackets and the tool kit mount is over them. Tighten the bolts securely.

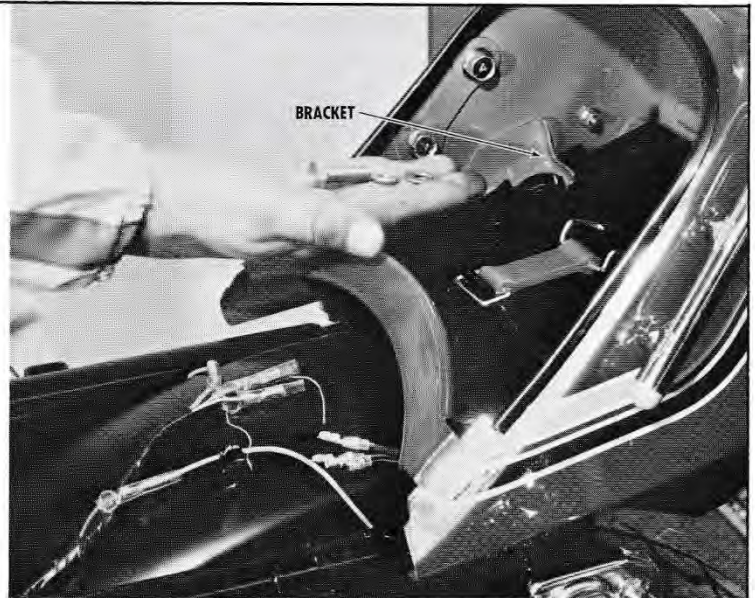

Make the wiring connections as shown, and then slip all the wires from the rear turn signals and the taillight under the clip on the fender. Bend the clip down to hold the wires in place.

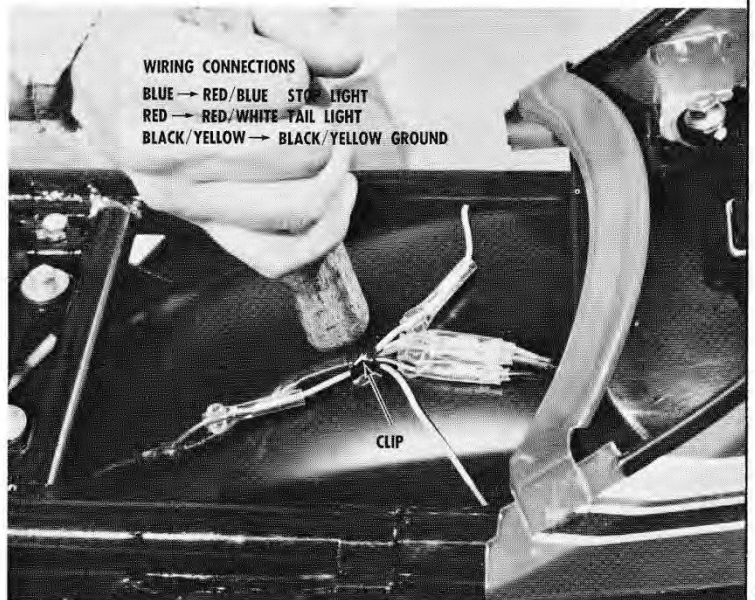

Install the seat assembly with the hinge pins, as shown. Be sure to install the safety clips.

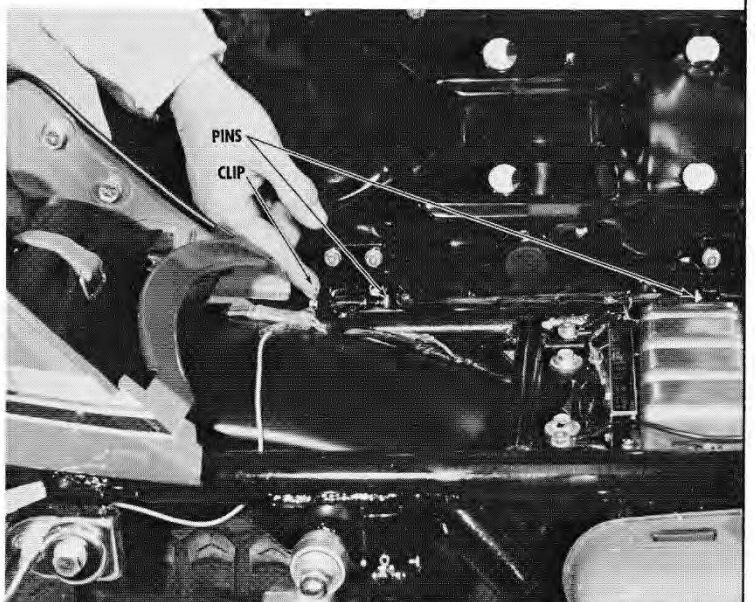

PREPARATION SERVICING

FILLING

Remove the battery cover and take the battery out of the motorcycle. Be sure that the battery vent hose has been cut or the rubber band removed. Fill the battery to the top level with fresh electrolyte fluid at a temperature of 85° F or less. Let the battery stand for two hours. If the fluid level drops below the upper line, refill the battery with more electrolyte before charging.

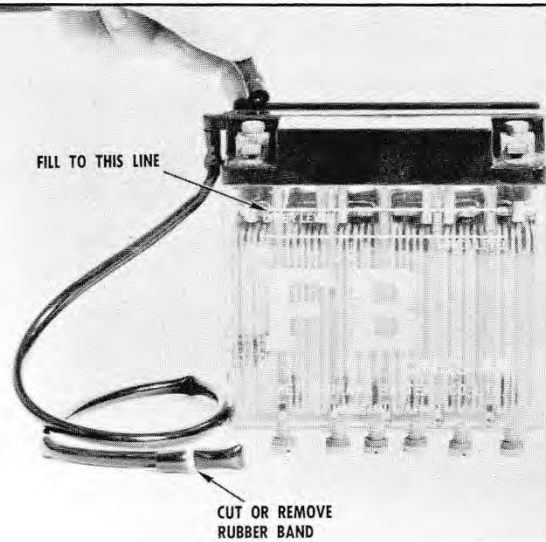

CHARGING

An initial charging is recommended before placing the battery in service. To avoid battery damage, remove all of the caps. Connect the battery charger leads (red to +, black to -) to the battery posts. CAUTION: Do not charge at a rate greater than 1 amp. Charge for 15 to 20 hours. Discontinue charging if the electrolyte temperature rises to 115°F. If the electrolyte level drops, refill the battery with **distilled water only**.

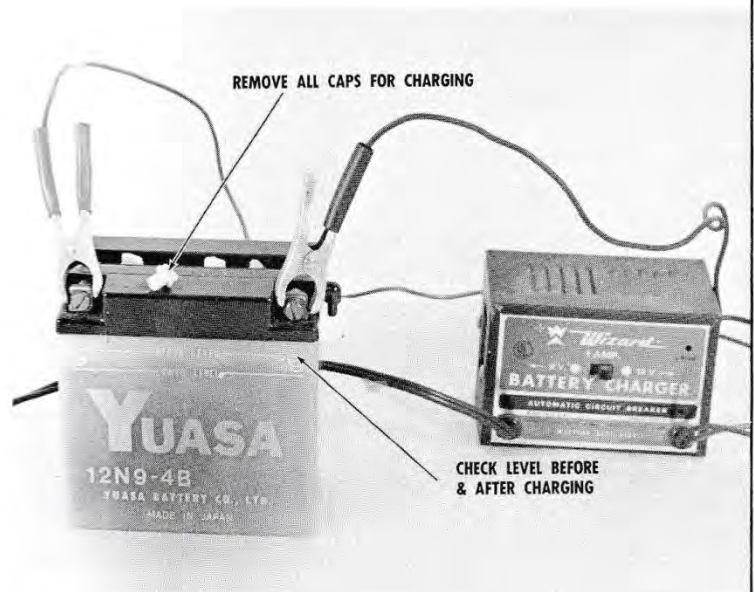

INSTALLATION

Wash off any spilled acid with fresh water. Be sure the battery damper rubbers are in position to accept and protect the battery. Slide the battery into the battery box so that the vent tube is on the outside. Connect the white wire from the fuse to the positive (+) battery post and slip the rubber boot into position. Replace the battery brackets and tighten the bolt securely. The seat has been removed for clarity.

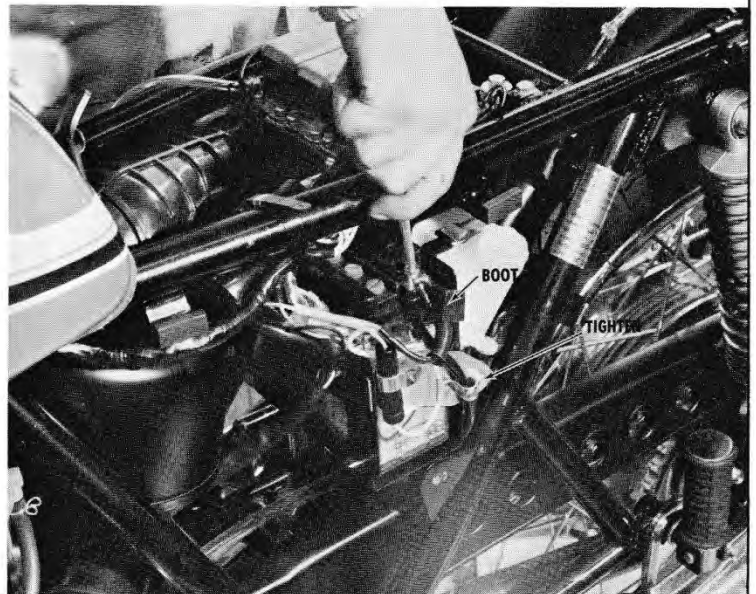

Connect the black ground wire to the negative (-) battery post. Check to be sure that the ground screw on the frame is tight.

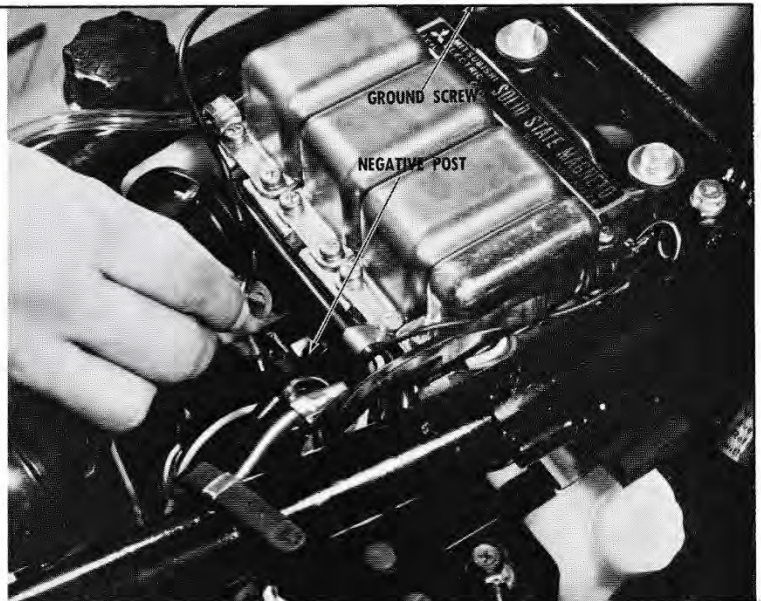

Route the battery vent hose through the clip on the battery bracket, under the battery box, and down through the clip on the rear fender.

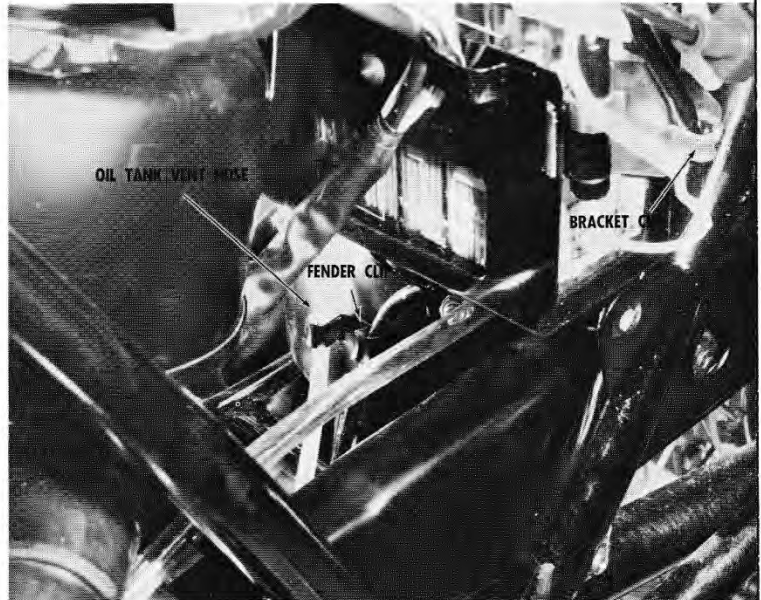

Remove the drain plug and drain the preservative oil from the transmission. Replace the drain plug and gasket, and tighten it securely.

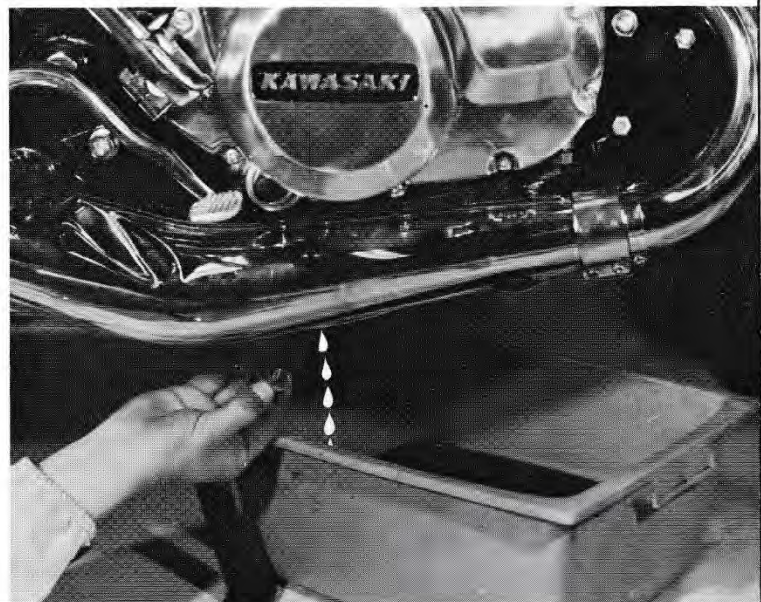

Fill the transmission with 1½ qts. (1.4 liters) of SAE 10W-40, 20W-50, or 10W-50 motor oil marked SD or SE. The oil level should be between the two marks on the filler cap dipstick when it is threaded all the way into the case. Make sure the O-ring is in place.

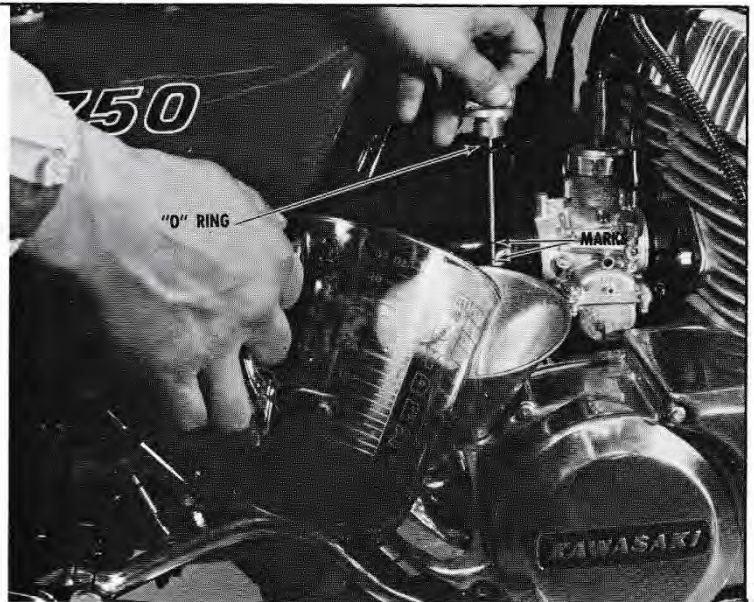

Remove the oil tank cover. Remove the oil tank filter and check to be sure it is free of foreign matter. Replace the filter, remove the oil tank cap, and fill the tank with a quality brand of 2-stroke oil. Make sure the oil tank vent hose is routed over the frame tube, through the clip near the CDI unit, and down through the clip on the rear fender (next to the battery vent hose). CAUTION: The oil tank filler cap is not vented. The plastic vent hose must be routed so that it will not be pinched by the seat. Be sure the vent tube is open. Replace the oil tank cover.



Check to see that the chain oiler hoses are clear and firmly attached to the oiler valve, and that the lower hose is routed through the hole on the top of the chain case cover. Remove the oiler tank cap and fill the tank with 5 fl. oz. of good quality SAE 30 motor oil.



Remove the oil pump cover. Loosen the oil inlet banjo bolt to bleed the oil inlet line from the oil tank. After two minutes of oil flow, tighten the bolt. CAUTION: If the oil flow is slow or stops altogether, check the oil tank filter for clogging and the oil hose for pinching. Check to be sure that the three oil outlet bolts are tight.

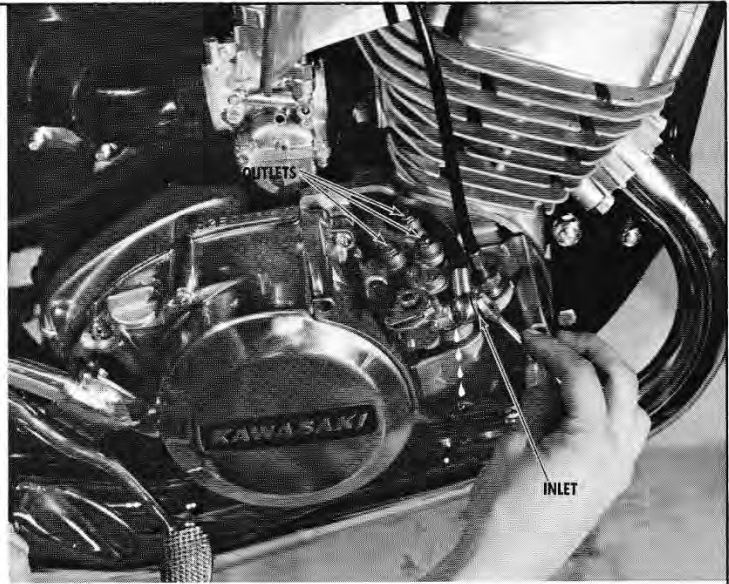

Start the engine and maintain a steady engine speed of 1500 to 2000 rpm. Hold the oil pump control lever in the wide-open position to bleed any air out of the oil pump body and oil pressure lines. When the exhaust starts to smoke heavily, release the lever and stop the engine. CAUTION: If the exhaust does not smoke, or if bubbles are present in the oil pressure lines, check for blockage or loose connections.

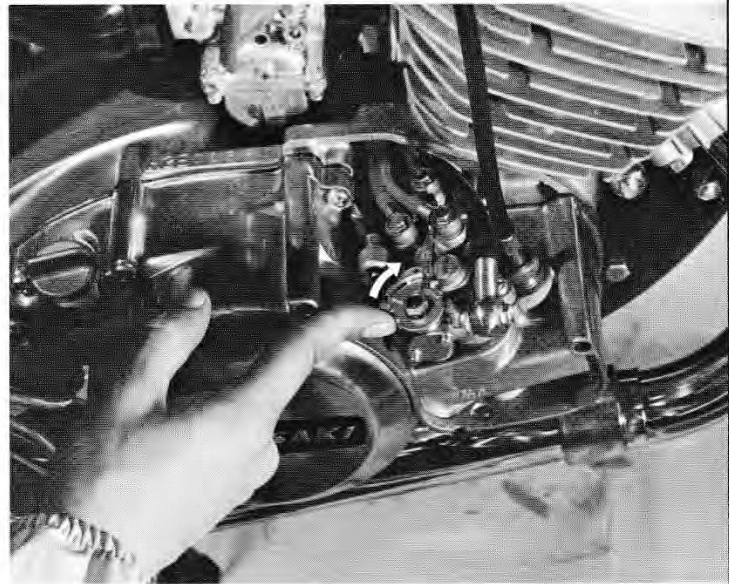

SETTING THE AIR GAP

Remove the ignition cover. Turn the engine until the tab on the signal generator rotor is aligned with the magnet in the center of one of the pick-ups. There should be a gap of 0.025 in. between the pick-up and the tab on the rotor. If the gap is incorrect, fully loosen the two screws "A" and adjust the pick-up by hand. Tighten the screws securely and repeat the procedure on the other two pick-ups. CAUTION: Do not pry on the pick-ups with a screwdriver or any other tool. Be sure the screws are completely loose before adjusting the pick-ups, or they may break.

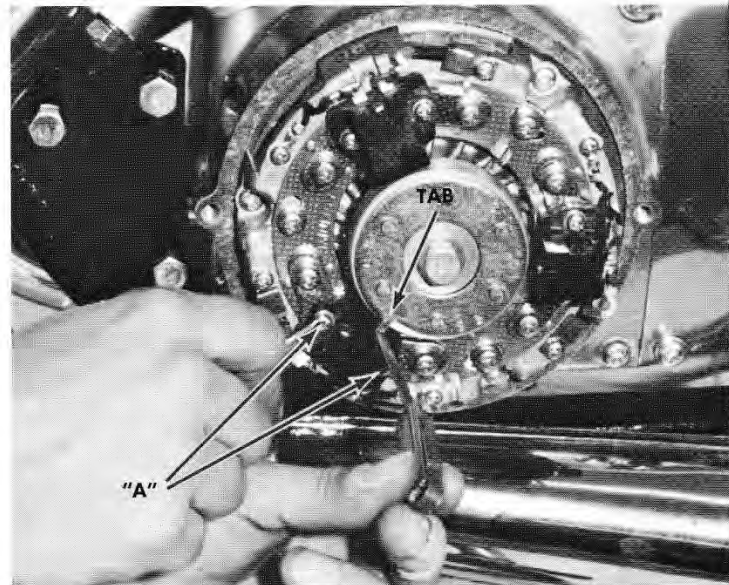



STATIC IGNITION TIMING

Remove the spark plug and fit a dial gauge to the left cylinder. Turn the crankshaft to top dead center and then rotate it clockwise until the dial gauge shows that the piston is 3.13mm BTDC.

The pointer should now align with the "L" mark on the rotor. If it does not, bend the pointer accordingly. Take out the dial indicator and replace the spark plug.

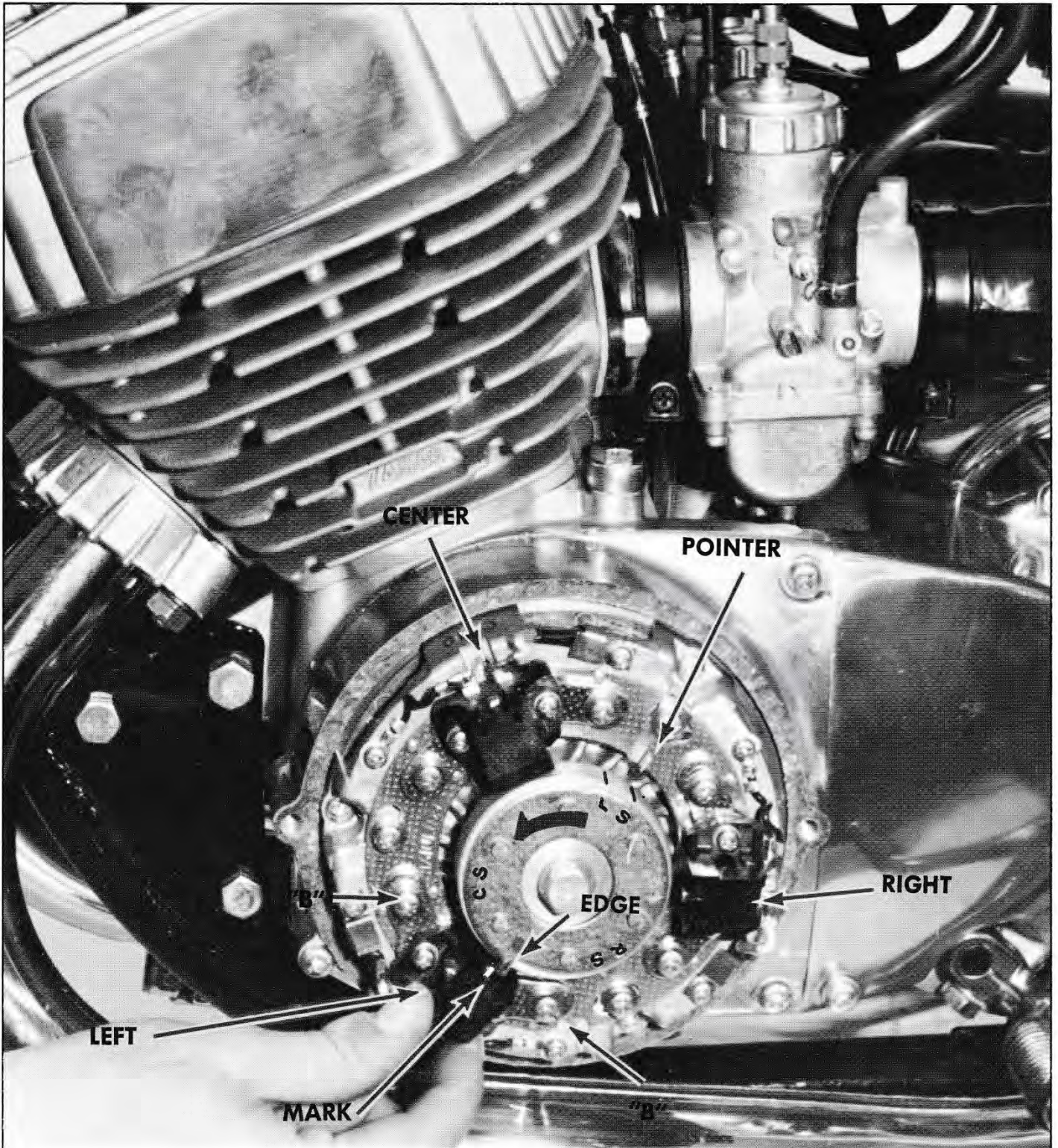

Turn the crankshaft in the direction shown until the "S" (static) mark nearest the "L" mark lines up with the pointer. The trailing edge of the rotor tab should align with the mark on the pick-up for the left-hand cylinder, as shown. If it does not loosen the two screws "B" and adjust the pick-up accordingly. Tighten the screws securely after adjustment.

Turn the crankshaft until the pointer aligns with the "S" mark nearest the "R" on the rotor. The trailing edge of the rotor tab should align with the mark on the pick-up for the right-hand cylinder. If it does not align, adjust the pick-up. Using the "S" mark nearest the "C" on the rotor, do the same for the center cylinder pick-up.

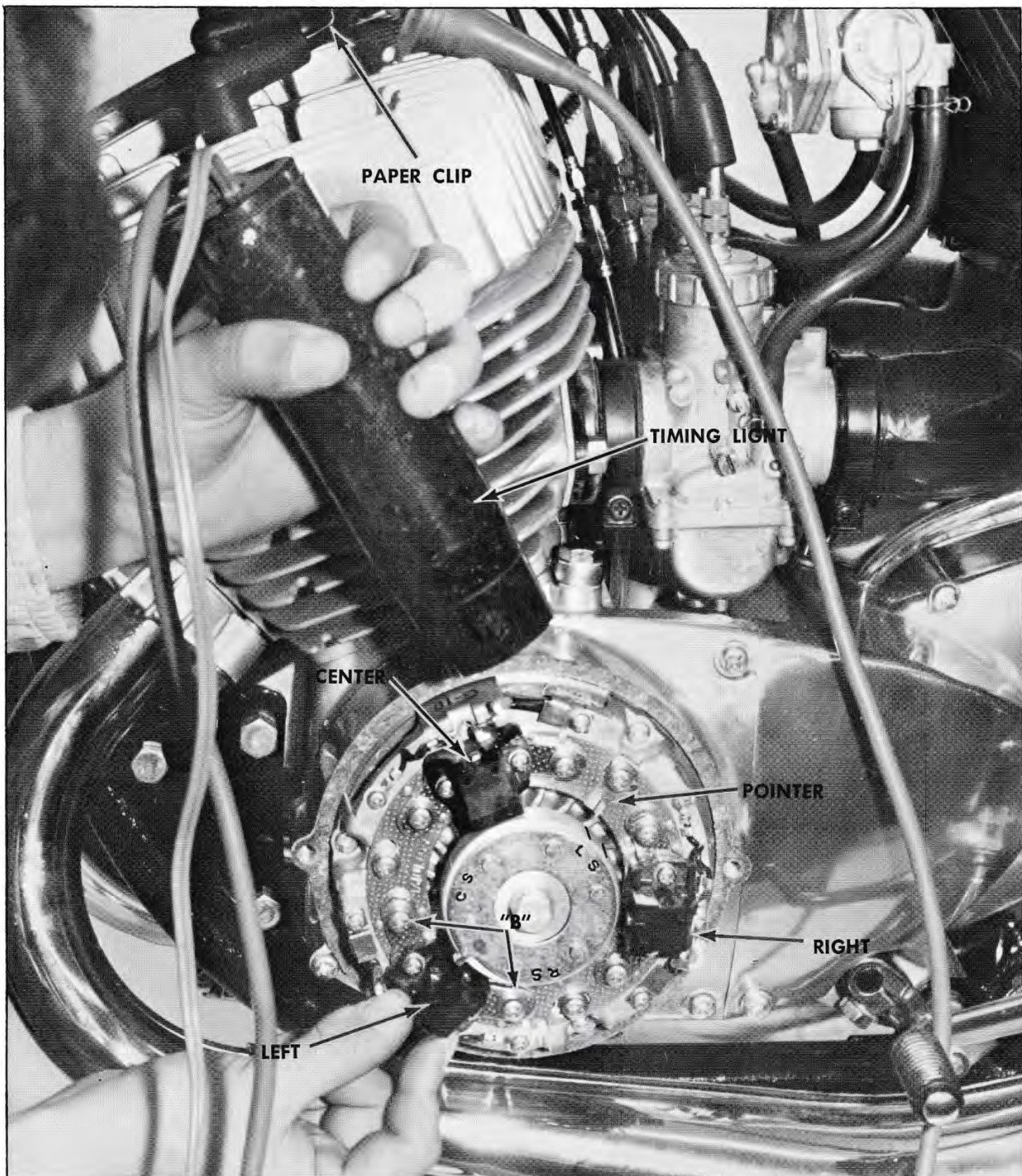

DYNAMIC IGNITION TIMING

Connect a stroboscopic timing light to the left-hand sparkplug wire. Start the engine and maintain a steady speed of 4000 rpm. Using the timing light, check to see that the pointer aligns with the "L" mark on the rotor. If it does not

align, loosen the two screws "B" and adjust the pick-up. After adjustment, tighten the screws securely. Repeat this procedure for the center and right-hand cylinder pick-ups, using the "C" and "R" marks, respectively.

STARTER CABLE ADJUSTMENT

Loosen the locknut and turn the adjuster in until the starter cable has at least $\frac{1}{4}$ " of slack. Do the same to the throttle cable.



Tug on the starter cables to check for free play, which should be $\frac{1}{8}$ " in each cable. NOTE: If there is no slack, the starter plunger will be held open slightly, causing rich mixtures from the carburetor. To adjust the cable slack, pull up the rubber cap, loosen the locknut, and turn the adjuster. Tighten the locknut after adjusting.

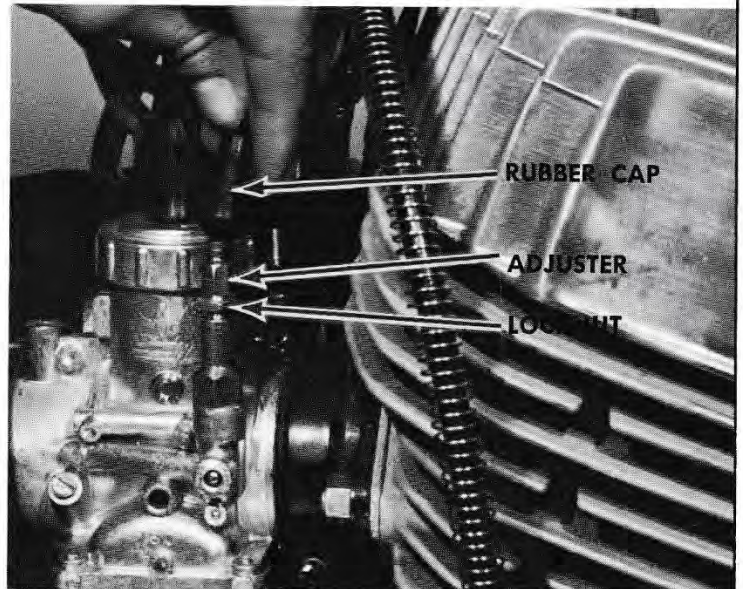

CARBURETOR SYNCHRONIZATION

For smooth, reliable performance, the three carburetors must all have the same slide position at any throttle opening. Pull up the rubber cap and remove the circlip from the groove in the adjuster on all three carburetors.

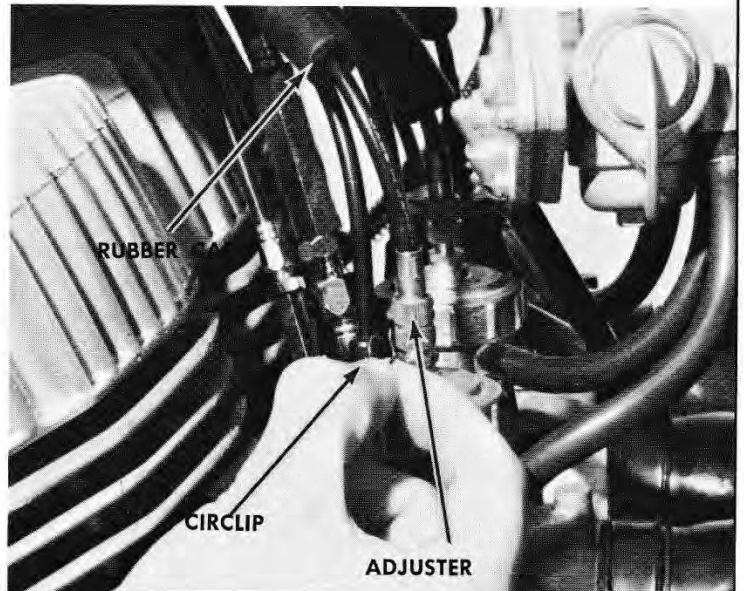

Turn the throttle stop screws all the way out, so that they do not hold the throttle slides open. The slides are now all fully closed. Tug on the throttle cables to make sure each cable has the same amount of slack: 1/16". Correct any tight or loose cable by loosening the locknut and turning the cable adjuster. When all three cables have 1/16" of slack, tighten the locknuts. Replace the circlips and push down the rubber caps. After this operation, the three slides will be parallel at any throttle position from fully closed to wide open.



IDLE ADJUSTMENT

Turn in each air screw until it bottoms lightly, and back it out 1 1/4 turns. Start the engine and warm it up for a minute or two; then back out the throttle stop screws until a stable idle of 1200 to 1400 rpm is obtained. Hold your hands over the mufflers to see if the exhaust pressure is balanced among the three cylinders. To balance the exhaust, turn the throttle stop screws — back out the screw on a "strong" cylinder; turn in the screw on a "weak" cylinder. Check the tightness of the carburetor and air inlet clamps and the inlet flange nuts.



Finally, lengthen the cable adjuster at the twist grip so that there is approximately 1/16" - 1/8" play in the throttle. Do the same to the starter cable.

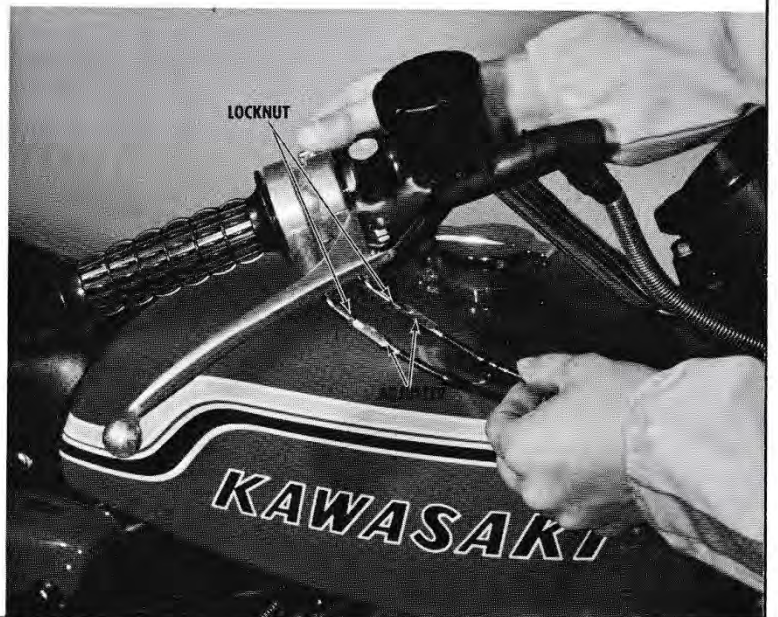

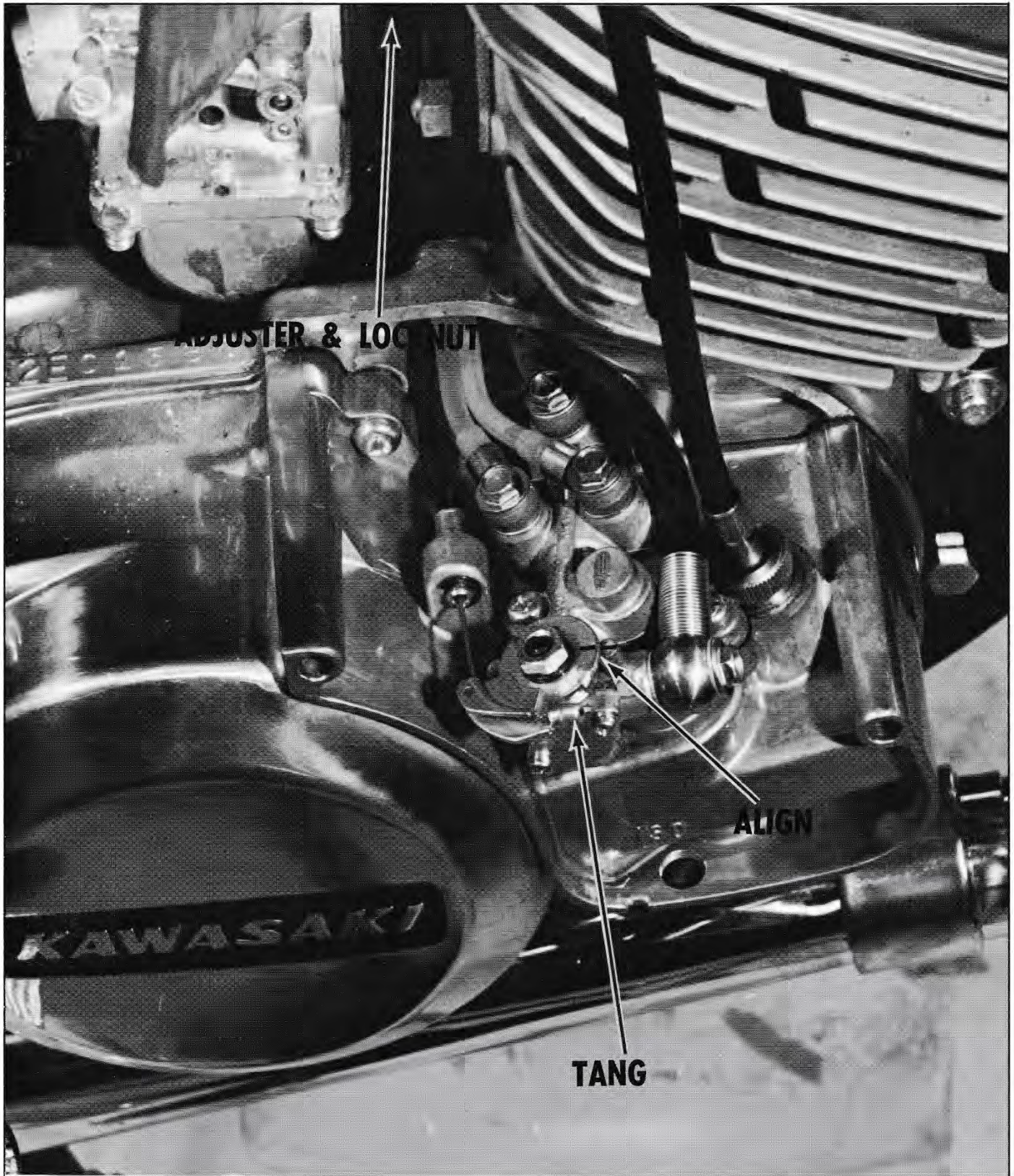

OIL PUMP ADJUSTMENT

Only after adjusting the carburetors, inspect the oil pump adjustment. Close the twist grip completely, and see that the mark on the oil pump lever aligns with the mark on the oil pump body just as the carburetor slides start to open.

If it does not align, loosen the locknut on the oil pump cable under the fuel tank and turn the adjuster. After adjusting, tighten the locknut securely. Check to be sure that the lever tang is bent over to retain the cable nipple.

CLUTCH ADJUSTMENT

Remove the sprocket cover and check the position of the clutch release lever, which should be at approximately 8 o'clock, as shown. Correct the lever position by turning the clutch cable adjuster under the fuel tank. After adjusting, be sure to tighten the locknut securely. Loosen the locknut on the release screw and turn the screw clockwise until you start to feel clutch spring tension. Hold the screw in this position while tightening the locknut. Check the tightness of the sprocket nut, making sure the washer is bent, and replace the sprocket cover.

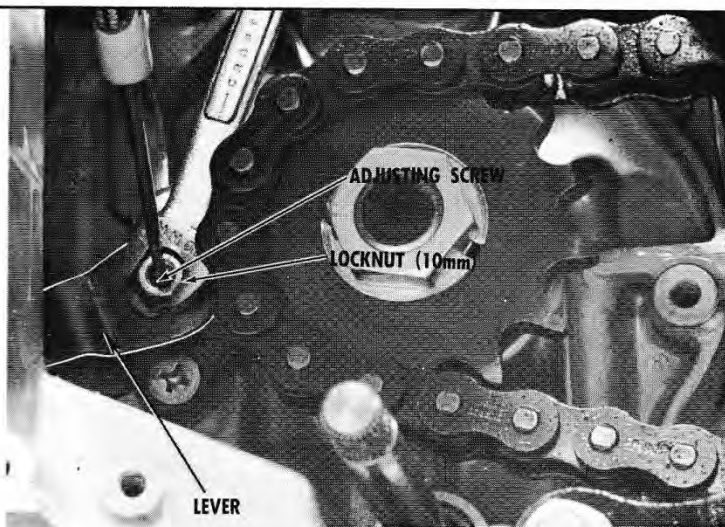

Turn the clutch cable adjuster on the handlebar to obtain $\frac{1}{8}$ " gap when you just start to feel clutch spring tension, and then tighten the thumbwheel.

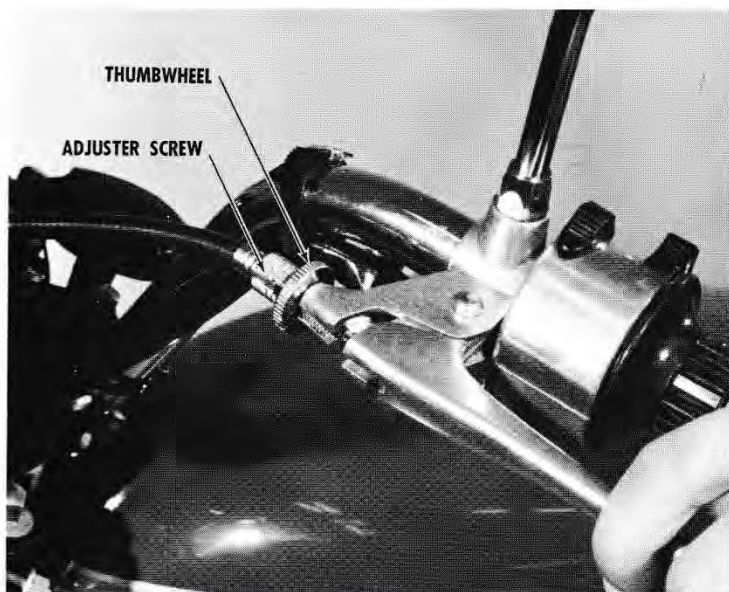

Check the fluid in the brake master cylinder reservoir with the reservoir held as nearly level as possible. If the fluid is below the line on the inside wall of the reservoir, fill it with one of the following recommended brake fluid brands:

- Atlas Extra Heavy Duty
- Shell Super Heavy Duty
- Texaco Super Heavy Duty
- Wagner Lockheed Heavy Duty

Check to be sure the master cylinder banjo bolt is tightened to 20 lb.-ft. of torque.

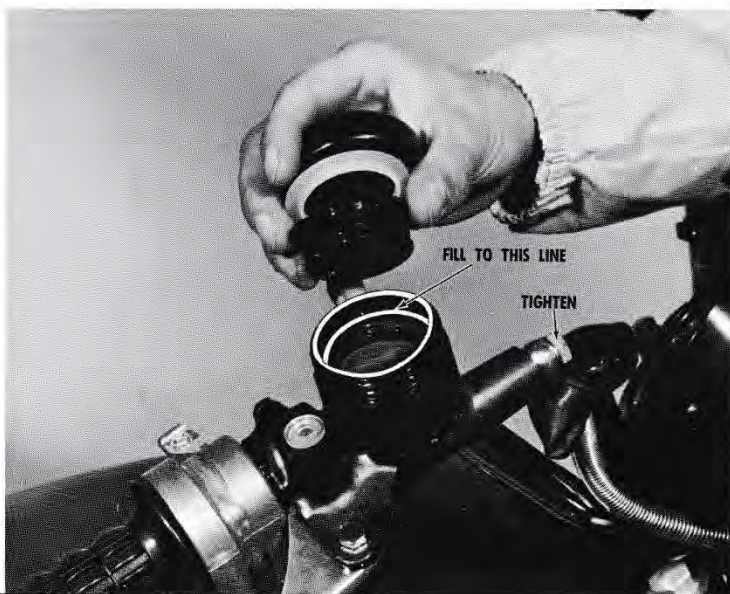

Check to be sure both banjo bolts on the three-way fitting are tightened to 20 lb.-ft. of torque. The brakelight switch should be tightened to 13 lb.-ft. of torque.

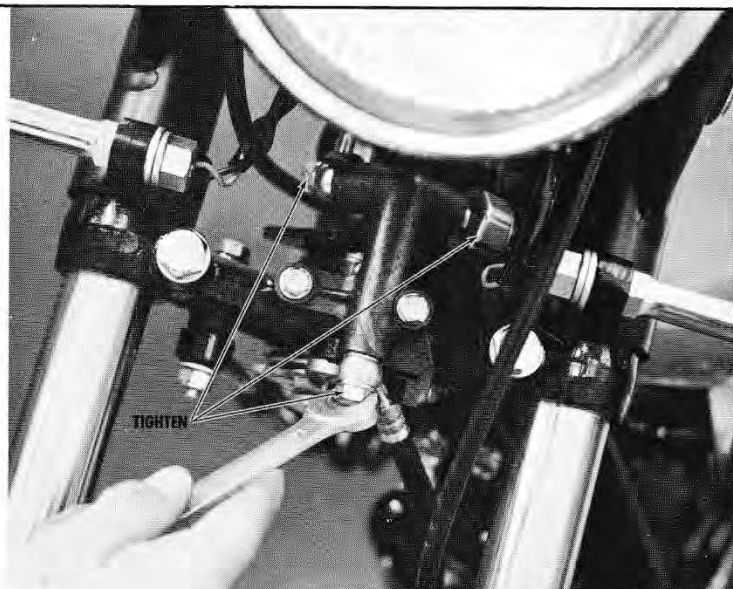

Check to be sure these hydraulic fittings are tightened to about 12.5 lb.-ft. of torque. The bleeder valve should be tightened to about 6.5 lb.-ft. of torque.



Remove the cotter pin and loosen the rear axle nut. Loosen the chain adjuster locknuts on either side of the swing arm. Push the rear wheel forward in the swing arm while turning the adjuster nuts until the drive chain has $\frac{5}{8}$ " to $\frac{3}{4}$ " of slack on the lower run of chain. Tighten the locknuts and the axle nut after adjustment. CAUTION: Be sure to replace the cotter pin. NOTE: To insure proper wheel and sprocket alignment, make sure the marks on the chain adjusters are positioned at equal divisions on the swing arm tabs. Adjust the rear shock absorbers to the "softest" position. The left-hand muffler has been removed for clarity. It is not necessary to remove it for this operation.

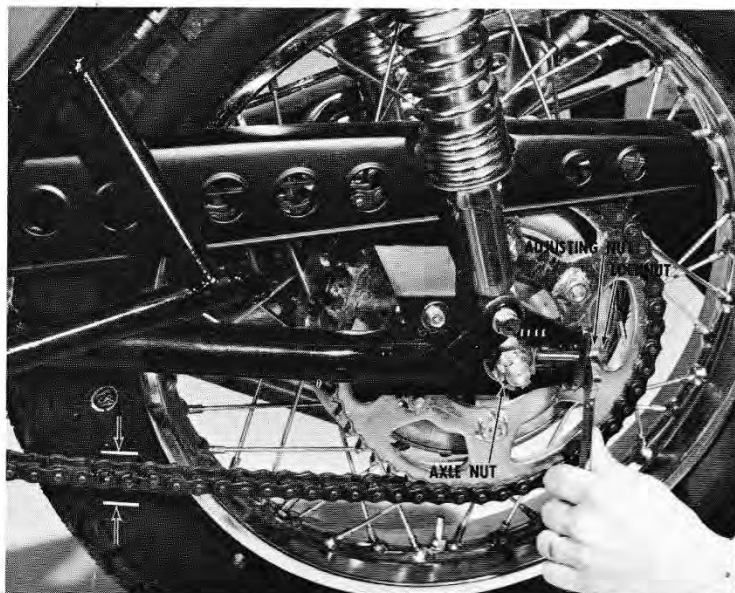

The rear brake pedal should be as high as possible without fouling the kickstarter lever or hitting the engine case. To adjust it, loosen the locknut and turn the adjuster bolt. Tighten the locknut securely after adjustment.

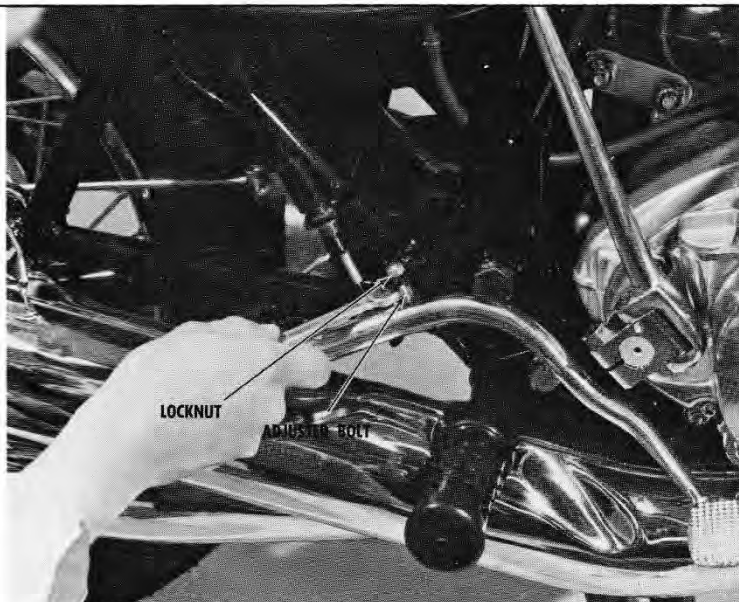

The rear brake pedal must have $\frac{1}{2}$ " to $\frac{5}{8}$ " of free movement. If it doesn't, turn the adjuster nut accordingly.

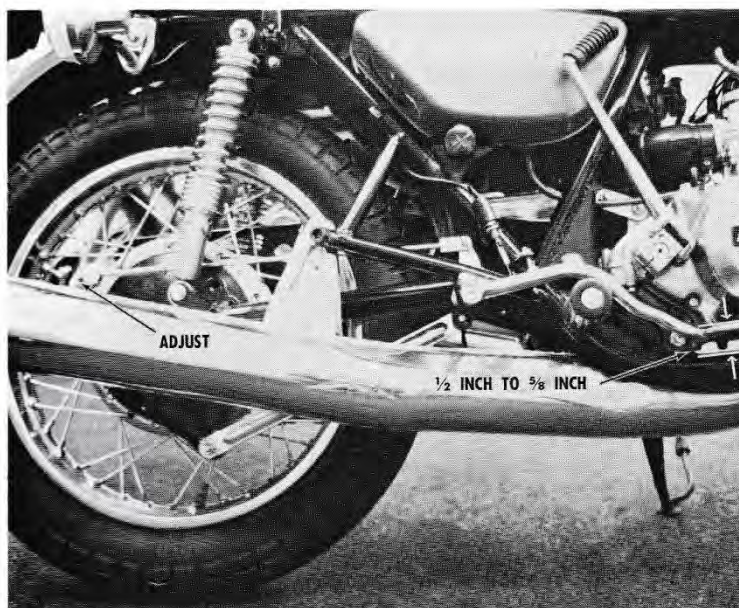

Turn on the main switch and operate the front and rear brakes individually. The front brake light switch does not require adjustment. The brake light should turn on when the rear brake pedal travels $\frac{3}{8}$ ". Adjust the brake lamp switch by loosening the locknut and turning the adjusting nut. Tighten the locknut after adjustment.



Wiring Diagram

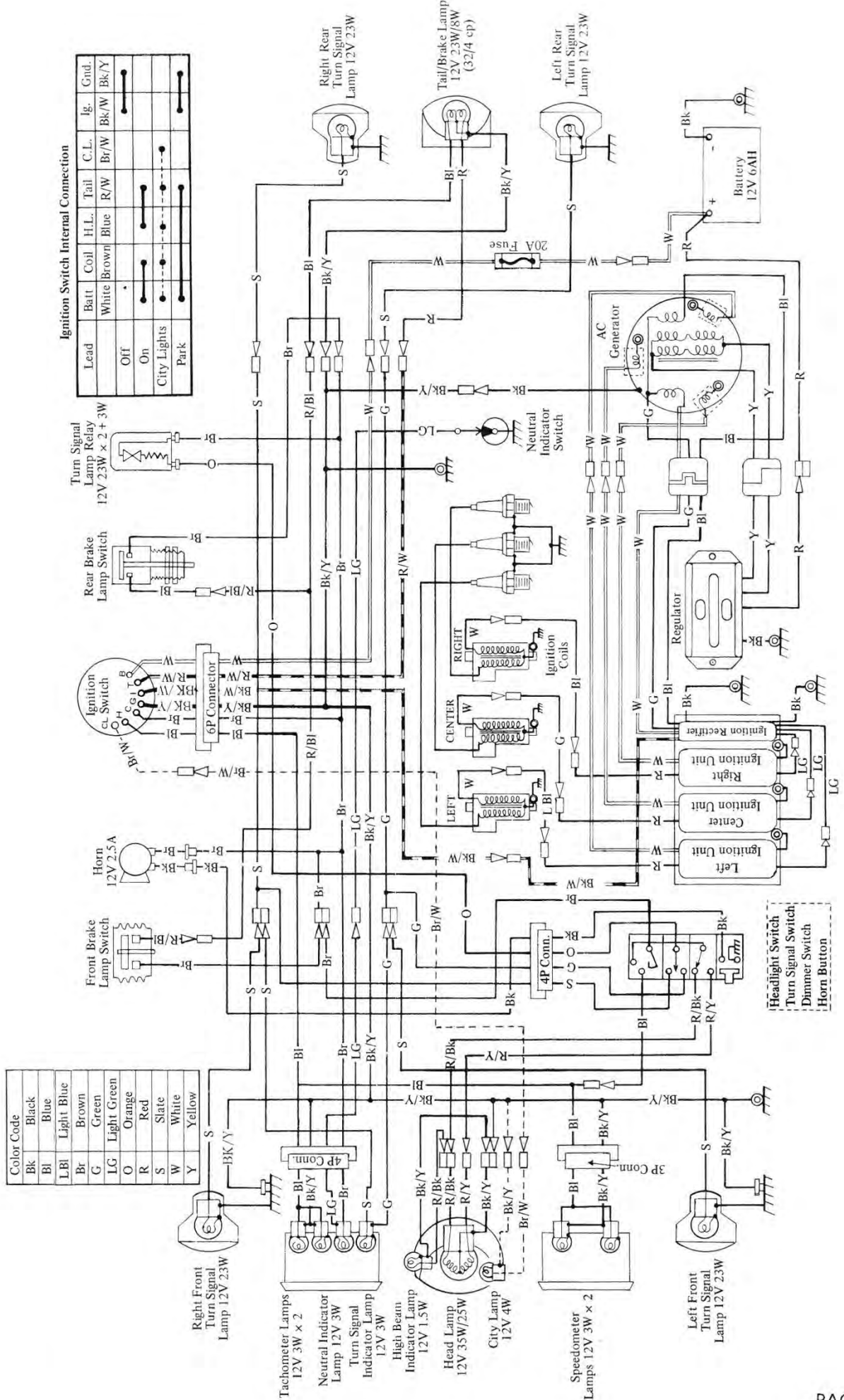

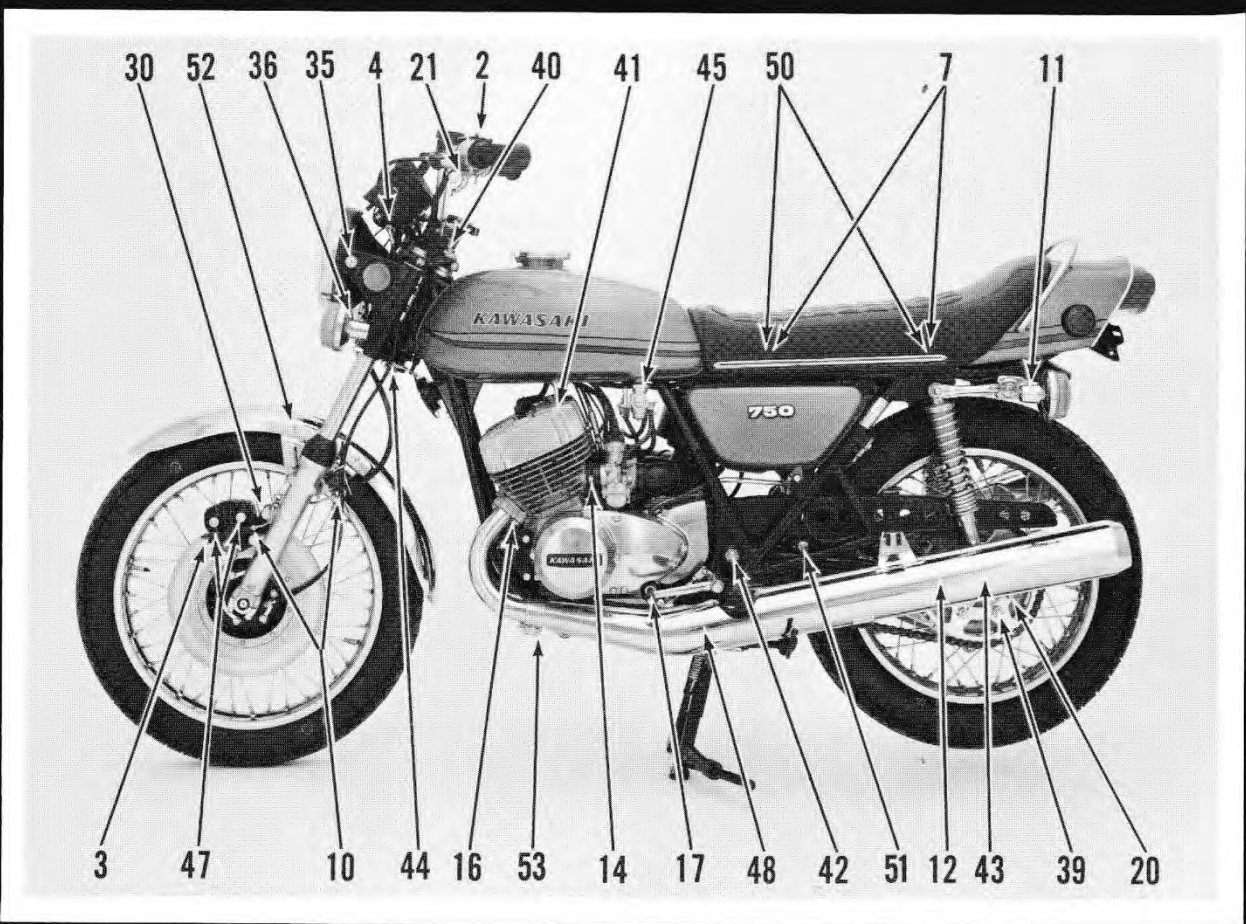
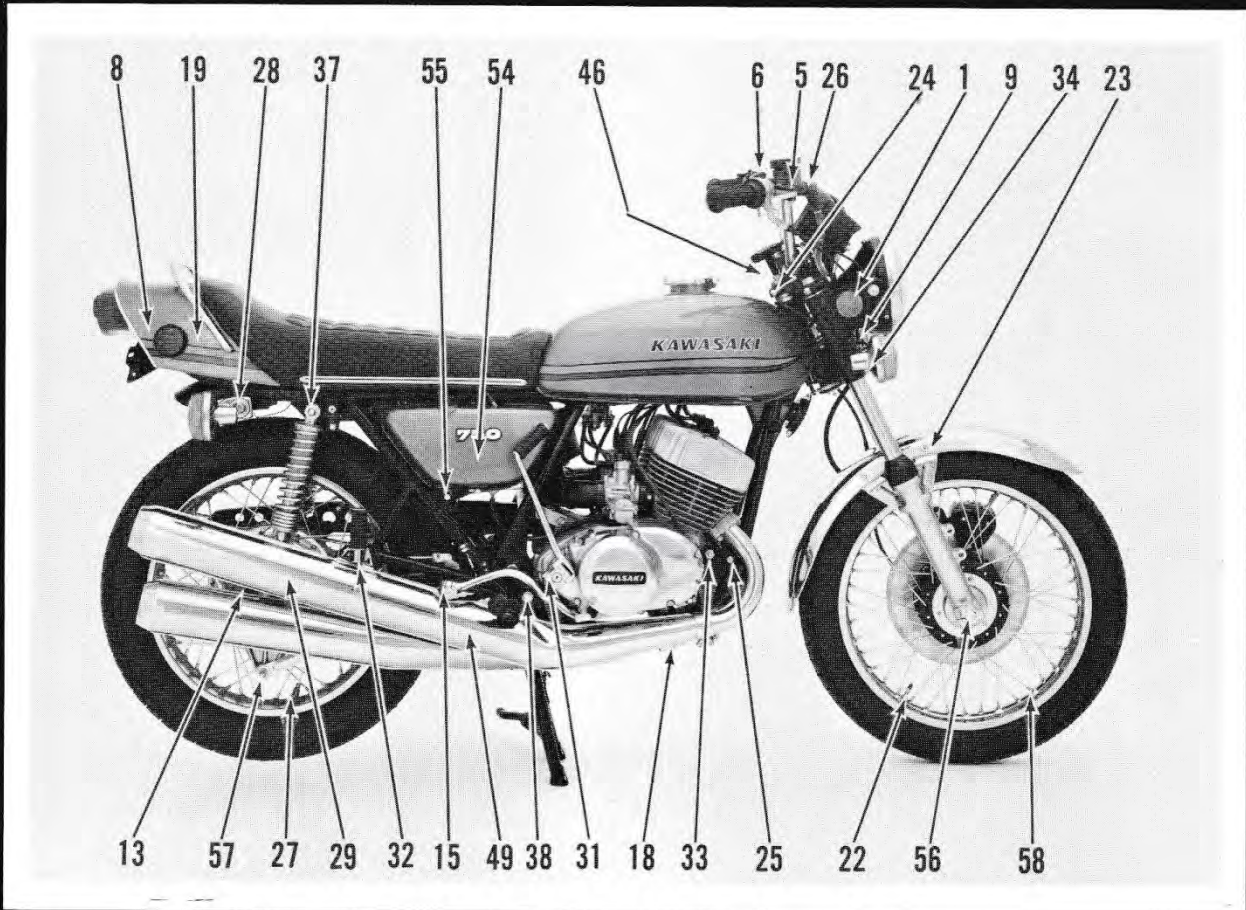

KAWASAKI MODEL H2-A
PRE-SALE SERVICE
CHECK THESE ITEMS BEFORE DELIVERY

ITEM	DESCRIPTION	TOOL SIZE	REMARKS
1.	Front & Rear Side Reflector Nuts (4)	8mm	
2.	Clutch Lever Pivot Nut	8mm	
3.	Brake Bleeder Valve	10mm	6.5 lb.-ft.
4.	Instrument Nuts (4)	10mm	
5.	Brake Lever Pivot Nut	10mm	
6.	Lever Bracket Clamp Bolts (3)	10mm	4.5 lb.-ft.
7.	Seat Hinge Bolts (4)	10mm	
8.	Tail Lamp Bracket Bolts (4)	10mm	
9.	Three-Way Fitting Bolts (2)	10mm	4 lb.-ft.
10.	Hydraulic Pipe Fittings (2)	10mm	12.5 lb.-ft.
11.	Turn Signal Housing Bolts (4)	10mm	
12.	Chain Guard Bolt	10mm	
13.	Rear Brake Actuating Lever Bolt	12mm	14 lb.-ft.
14.	Carburetor Manifold Nuts (6)	12mm	
15.	Brake Pedal Clamp Bolt	13mm	14 lb.-ft.
16.	Exhaust Flange Nuts (6)	13mm	
17.	Shift Lever Bolt	13mm	
18.	Front Muffler Bolts (2)	13mm	
19.	Backrest Bolts (8)	13mm	
20.	Chain Adjuster Locknuts (2)	13mm	
21.	Handlebar Clamp Bolts (4)	13mm	15 lb.-ft.
22.	Front Axle Clamp Nuts (4)	13mm	
23.	Front Fender Mount Bolts (4)	13mm	
24.	Top Triple Clamp Nuts (3)	13mm	
25.	Engine Bracket Nuts (2)	13mm	
26.	Brake Hose Banjo Bolts (3)	14mm	20 lb.-ft.
27.	Lower Shock Absorber Bolts (2)	14mm	
28.	Rear Turn Signal Mount Bolts (2)	14mm	
29.	Rear Brake Torque Link Nut	14mm	w/safety clip
30.	Caliper Bracket Bolts (2)	14mm	20 lb.-ft.
31.	Kickstarter Lever Bolt	14mm	
32.	Passenger Peg Nuts (2)	14mm	w/lockwashers
33.	Engine Mount Nuts (4)	17mm	
34.	Lower Triple Clamp Bolts (2)	17mm	
35.	Headlight Mount Bolts (2)	17mm	
36.	Front Turn Signal Mount Nuts (2)	17mm	
37.	Upper Shock Absorber Nuts (2)	17mm	
38.	Footrest Bolts (2)	17mm	
39.	Sprocket Bolts (6)	17mm	w/lockplates
40.	Detent Spring Nut	17mm	
41.	Cylinder Head Nuts (12)	19mm	16 lb.-ft.
42.	Swing Arm Pivot Nut	24mm	150 lb.-ft.
43.	Rear Axle Nut	27mm	w/cotter pin
44.	Hydraulic Brake Light Switch	27mm	13 lb.-ft.
45.	Fuel Valve Nut	30mm	
46.	Steering Bearing Nut	42mm	No binding, no excess play
47.	Caliper Bolts	10mm Allen Head	24 lb.-ft.
48.	Center Stand Pivot Joints (2)	Washer & Cotter Pin	
49.	Rear Brake Torque Link	Washer & Safety Clip	
50.	Seat Hinge Pins (2)	Safety Clip	
51.	Chain Guard Screws (2)	#2 Phillips	
52.	Front Fender Screws (4)	#2 Phillips	w/self-locking nuts
53.	Exhaust Pipe Clamp Screws (9)	#2 Phillips	
54.	Oil Tank Strap Screws (2)	#2 Phillips	
55.	Oil Tank Cover Screw	#2 Phillips	
56.	Tire Pressure Front	26 PSI	
57.	Tire Pressure Rear	31 PSI	
58.	Spoke Nipples		Check & Tighten

KAWASAKI MODEL H2-A SERVICE SPECIFICATIONS

CARBURETOR

Manufacturer & Type	Mikuni VM30SC
Float Level	24mm + 1mm
Fuel Level	30mm + 1mm
Main Jet Size & Type	#97.5R
Needle Jet/Primary Choke	#0-6/8mm
Jet Needle & Clip Position	#5EJ15-3rd
Pilot Jet	#35
Throttle Valve Cutaway	#2.5
Air Screw (Turns Out)	1½

IGNITION

Signal Generator Air Gap	0.025 in.
Ignition Timing — Initial Setting	3.13mm BTDC
Ignition Timing @4000 rpm	23°
Spark Plug Type	NGK B-9HS-10
Spark Plug Gap	0.040 in.

LUBRICANTS

Front Fork Oil Type	SAE 10W
Front Fork Oil Level	448mm from top
Front Fork Oil Quantity (Each Leg)	160 cc
Transmission Oil Type	SAE 10W-40, 20W-50, 10W-50 marked SD or SE
Transmission Oil Quantity	1.5 qt. 1.4 Liter 48 fl. oz.
Chain Oiler Type	SAE 30

