

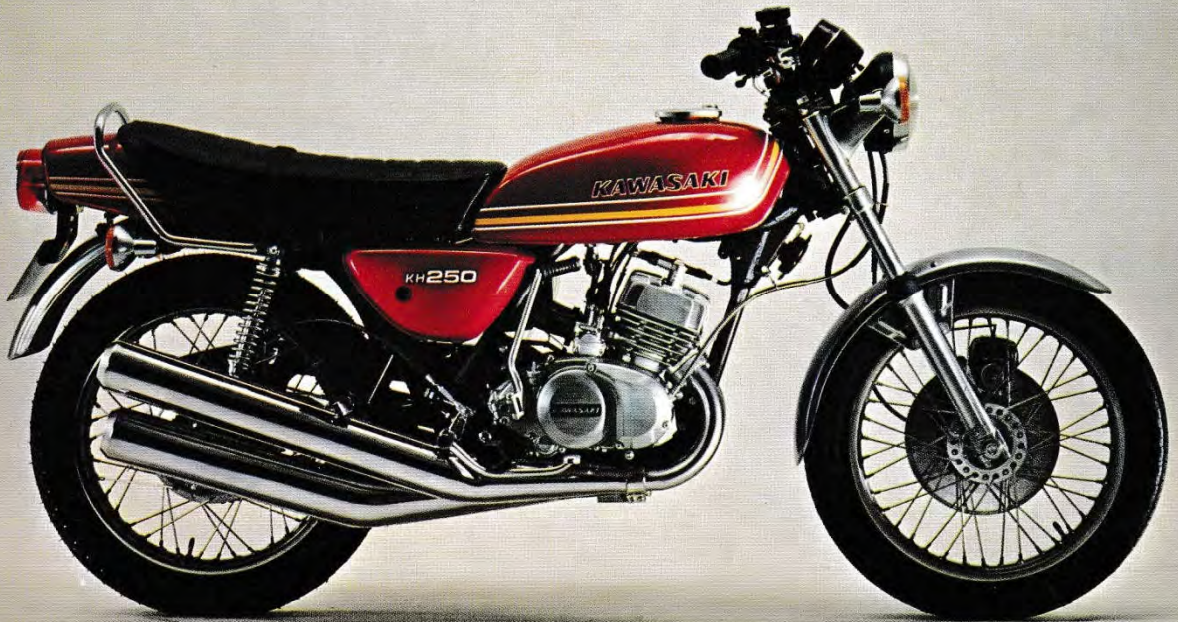

**Kawasaki**

**KH250-B1**



**MOTORCYCLE  
ASSEMBLY & PREPARATION  
MANUAL**



## **NOTICE TO DEALERS**

This manual is provided to insure that the motorcycle is assembled correctly and given proper presale preparation. Your customer expects and deserves a safe, reliable motorcycle, and performance of the steps listed here is essential to that end.

The selling dealer assumes sole responsibility for any unauthorized modifications prior to sale. Refer to your Service Binder for any Service Bulletins specifying Factory Directed Modifications (Special Claims) which must be performed before the motorcycle is ready for sale.

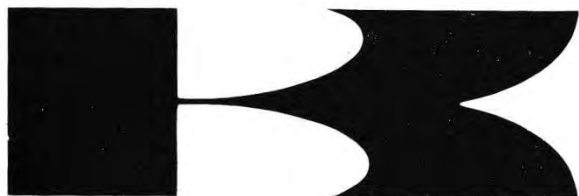

**Kawasaki**

**KH250-B1**



# **MOTORCYCLE ASSEMBLY & PREPARATION MANUAL**

## **TABLE OF CONTENTS**

|                                       |    |
|---------------------------------------|----|
| <b>MODEL IDENTIFICATION</b> .....     | 2  |
| <b>ASSEMBLY INSTRUCTIONS</b> .....    | 4  |
| <b>PREPARATION INSTRUCTIONS</b> ..... | 11 |
| <b>APPENDIX</b>                       |    |
| <b>SPECIFICATIONS</b> .....           | 17 |
| <b>CHECK AND TIGHTEN</b> .....        | 18 |
| <b>TEST RIDE THE MOTORCYCLE</b> ..... | 21 |
| <b>WIRING DIAGRAMS</b> .....          | 22 |

# Model Identification



BEGINNING

Engine No. S1E26600

Frame No. S1F-24400



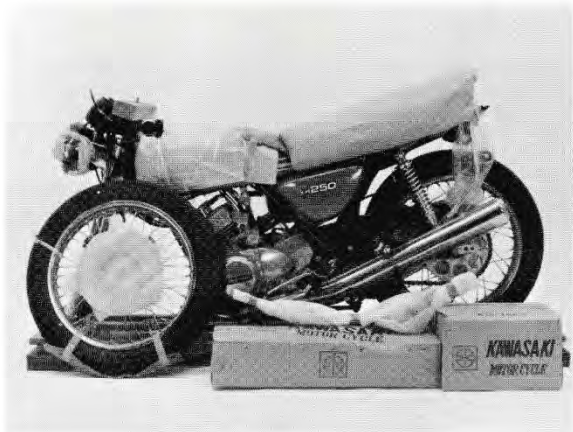

Clear work area. Set the crate upright on base and open the crate.

**CAUTION:** Bend over all exposed nails to prevent injury or a tire puncture.

Collect the front wheel, front fender, handlebar, rear fender, seat, and parts boxes. With an assistant, remove the unit to the set up area.

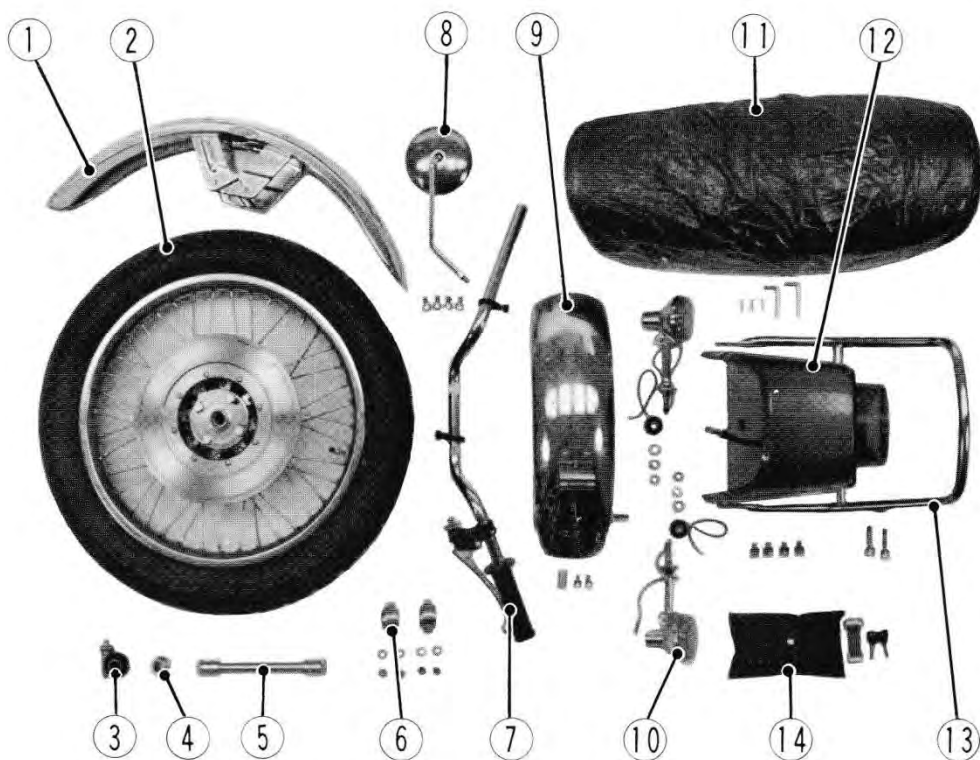

Open parts boxes and check for damage or missing parts.

1. Front fender, with four bolts and lock washers
2. Front wheel assembly
3. Speedometer gear box
4. Axle collar
5. Front axle, with sleeve nuts
6. Axle clamps, with four lock washers, and lock nuts
7. Handlebar assembly, with wiring straps
8. Rear view mirror
9. Rear fender, with two bolts, lock washers, flat washers, and a collar
10. Rear turn signals, each with a ground wire, flat washer, lock washer, and nut
11. Seat, with two link pins, and three safety clips
12. Seat back rest, with four bolts, lock washers, and flat washers
13. Passenger grab rail, with two long bolts, lock washers, and flat washers
14. Tool kit, rubber band, ignition keys
15. Miscellaneous:  
KH250 Owner's manual



# Assembly

## FRONT FENDER

Turn the lower front forks so that the fender mounting lugs face inward.

Mount the front fender with four bolts and lock washers. Be sure to mount the brake hose bracket between the fender and the left-hand fork tube.

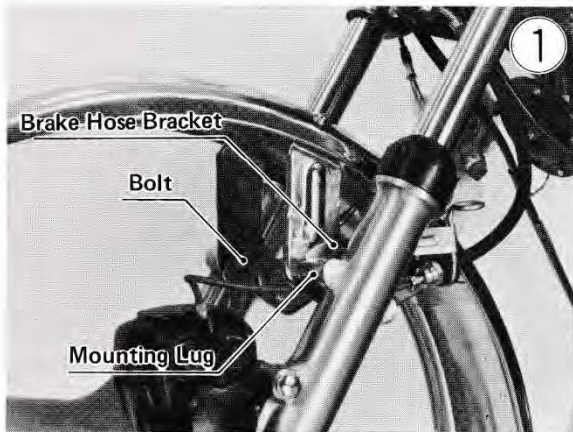

Make sure the protective rubber grommet on the brake hose is properly in the brake hose brace.

**CAUTION:** Do not bend the hydraulic brake pipe during assembly, or it may cause the brake to squeal.

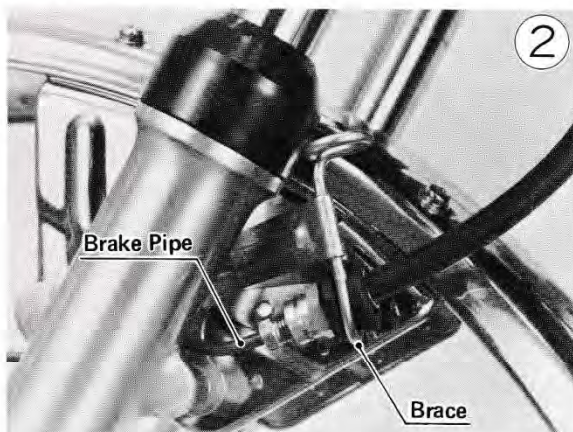

## FRONT WHEEL ASSEMBLY

Check for any loose parts inside the speedometer gear box and the front wheel hub, and fit the gear box to the hub. Be sure to align the tangs in the gear box with the slots in the wheel hub.

**WARNING:** Loose parts in speedometer gear box, or misalignment may cause front wheel to lock with resulting loss of control.

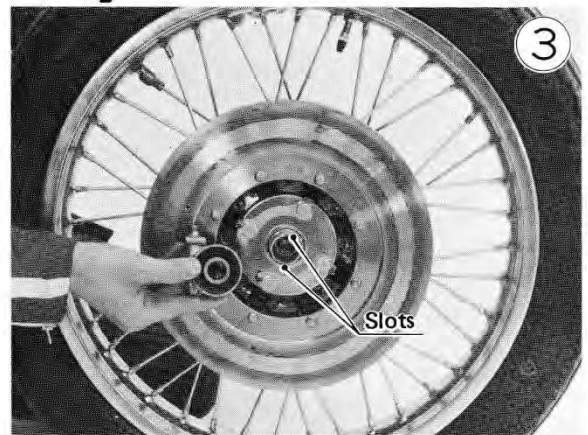

Insert the axle collar into the hub grease seal and thread in the axle.

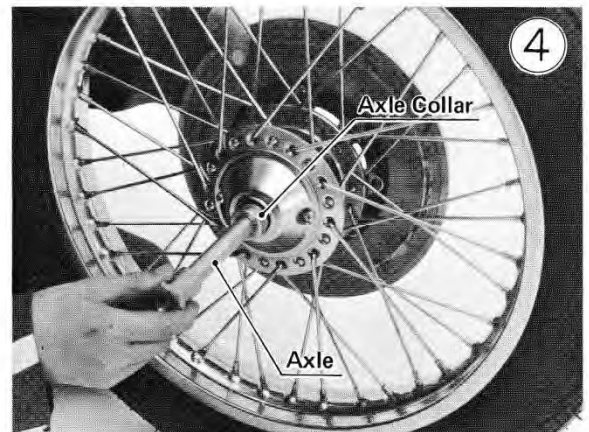

Tighten the axle with 7 ~ 9 kg-m (51 ~ 65 ft-lbs) of torque, and then turn the speedometer gear box to check for binding.

**WARNING:** If the axle is not securely tightened, an unsafe riding condition may result.





Wipe the disc clean with trichloroethylene or other oilless solvent.

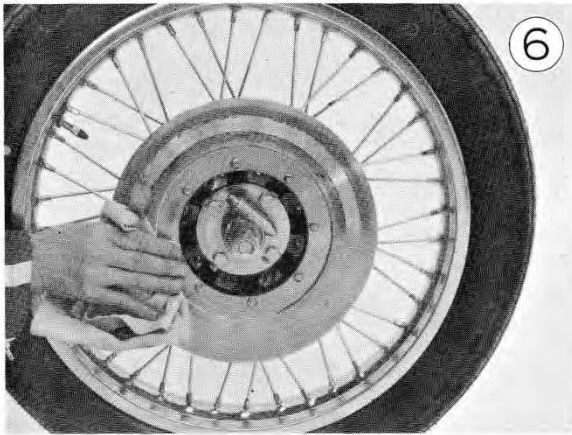

### FRONT WHEEL INSTALLATION

Pull the plastic guards off the axle clamp studs and check the studs for damaged threads. Slit the guard lengthwise with a sharp knife if it is stuck.

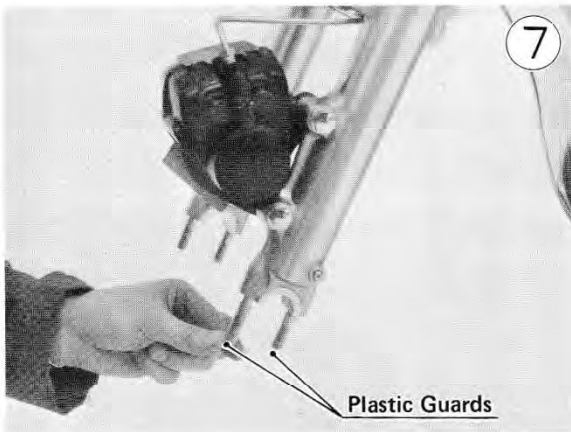

Remove the cardboard spacer form between the disc brake pads. Roll the front wheel into position with the disc between the caliper pads and the axle ends fitted between the studs on the ends on the lower front forks.

**NOTE:** Install the wheel with the speedometer gear box pointing rearward, because it may not turn to the correct position later.

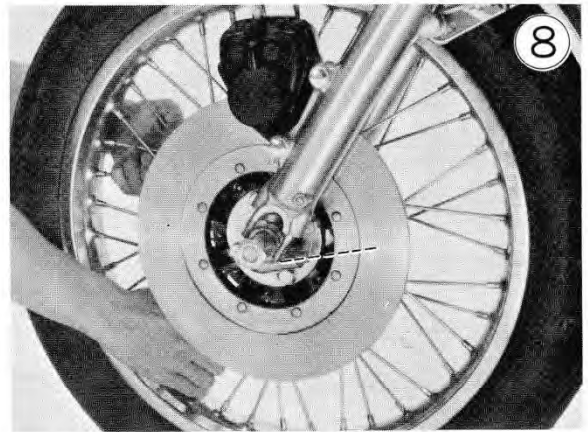

Loosely mount the axle clamps with a nut and lock washer on each stud, making sure the arrow on the clamp points toward the front of the motorcycle.

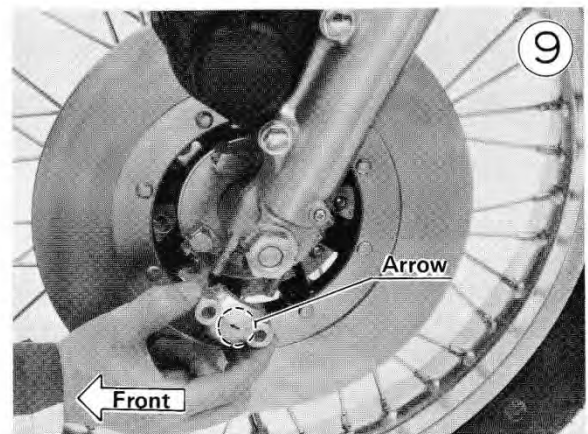

Turn the speedometer gear box so that it points to the two o'clock position. Be sure that the small projection on the gear box does not catch on the lower part of the left front fork. **CAUTION:** Failure to correctly align speedometer gear box may result in early breakage of the speedometer cable.

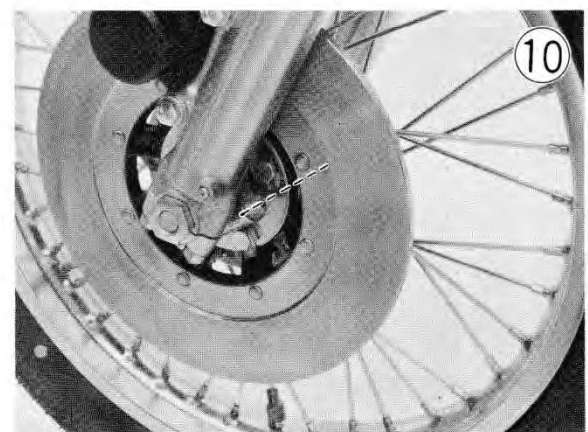

## 6 ASSEMBLY

Tighten the left hand clamp nuts, front first and rear last to 1.6 ~ 2.2 kg-m (11.5 ~ 16 ft-lbs). Compress the forks several times to center the axle, and then tighten the right-hand clamp in the same manner. If the axle clamp was correctly installed, there will be no gap at the front and an even gap at the rear after tightening.

**WARNING:** If the axle clamps are not correctly installed, or are not correctly tightened, an unsafe riding condition may result.

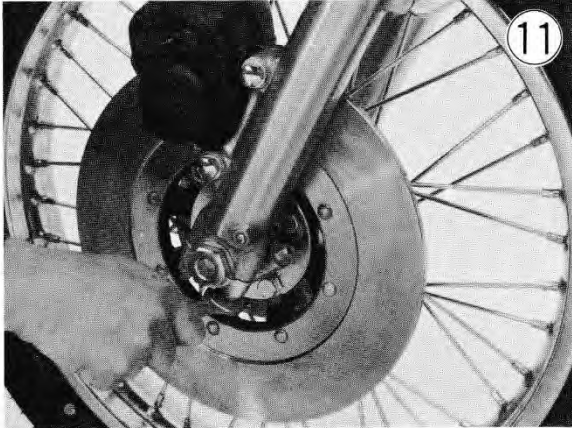

Route the lower end of the speedometer cable through the cable guide on the brake hose bracket. Insert the cable into its socket, while slowly rotating the front wheel to insure proper engagement. Screw on the cable nut and tighten it securely.



### HANDLEBAR

Remove the master cylinder clamp bolts to separate it from the wooden crossbar, and then put the master cylinder near the instruments temporarily. Remove the nut holdign the crossbar to the handlebar clamps.

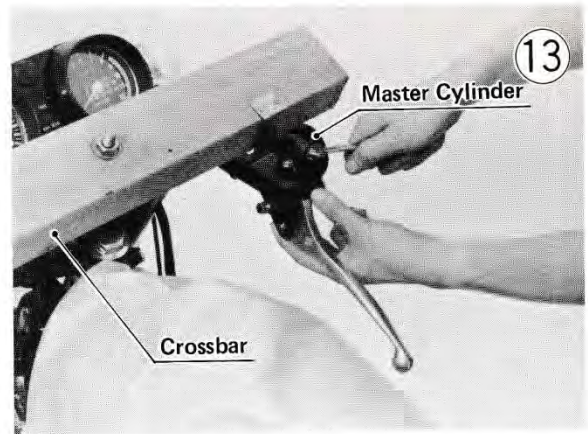

Remove the handlebar clamp bolts and discard the metal plate, long bolt, and crossbar.

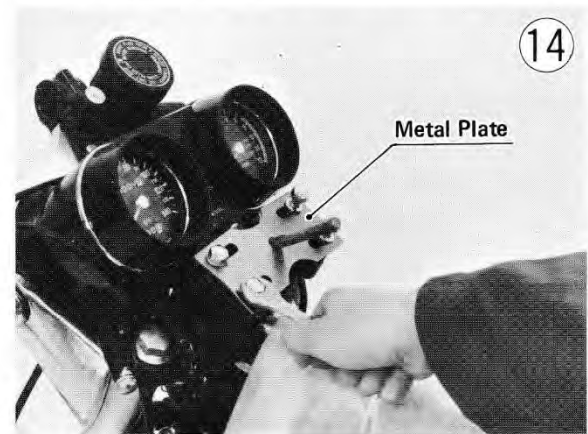

Before mounting the handlebar in position, slide the throttle grip assembly onto the right-hand end of the handlebar. Do not tighten the screws yet.

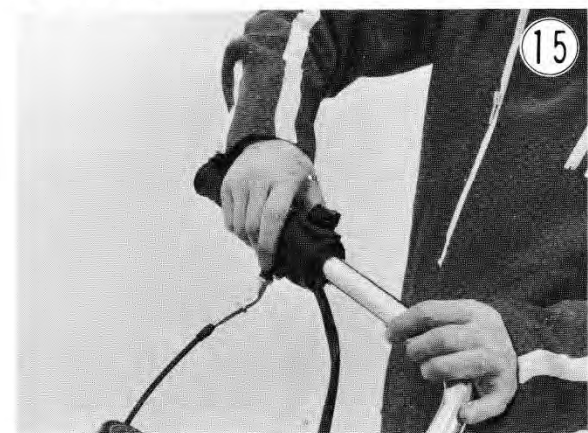

Set the handlebar in position, fit the clamps, and screw in the clamp bolts. Tighten the clamp bolts evenly with 1.6 ~ 2.2 kg-m (11.5 ~ 16.0 ft-lbs) of torque.



**NOTE:** Comfortable handlebar position is obtained by matching the handlebar angle with that of the front forks.

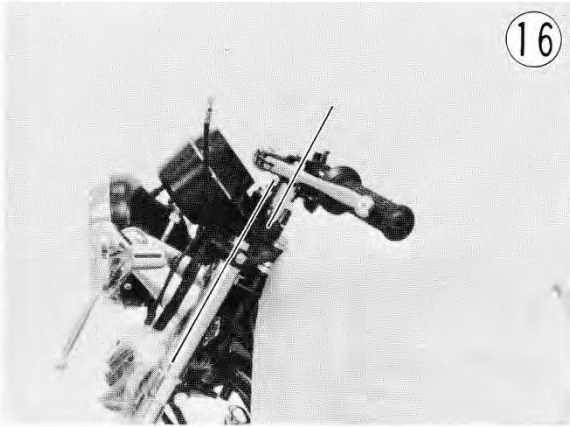

### THROTTLE GRIP ASSEMBLY

Tighten the throttle grip mounting screws securely with the engine stop switch at topmost position on the handlebar.

**WARNING:** Do not push the throttle grip so far onto the handlebar that the inside of the grip contacts the end of the bar. This can interfere with throttle action and could result in loss of control.

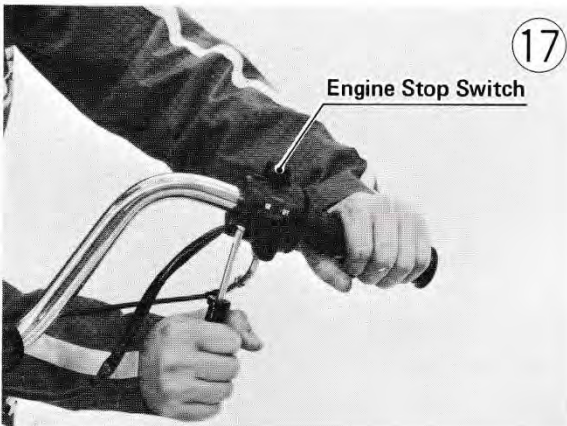

### MASTER CYLINDER

Mount the front brake master cylinder next to the throttle grip assembly. The small projection on the side of the clamp should face toward the grip. Tighten first the upper clamp bolt and then the lower, both with 0.6 ~ 0.9 kg-m (52 ~ 78 in-lbs) of torque.

**NOTE:** If the clamp was correctly installed, there will be no gap at the top and an even gap at the bottom after tightening.

**CAUTION:** Make a proper space between the master cylinder holder and the throttle grip assembly so that the grip assembly does not limit the brake lever action.

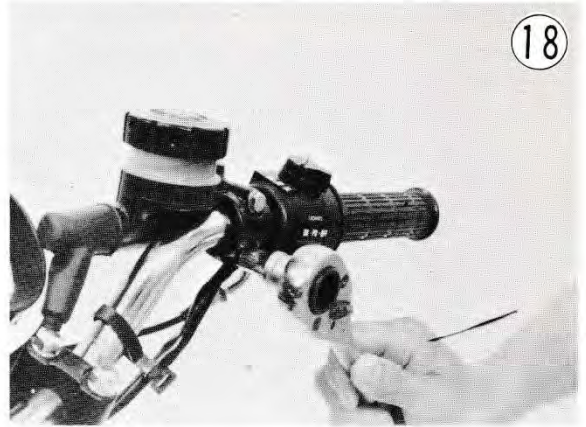

### LEFT-HAND SWITCH HOUSING

Mount the left-hand switch housing between the grip and the clutch lever bracket. Position the switch housing so all controls are reached easily, and tighten the mounting screws.

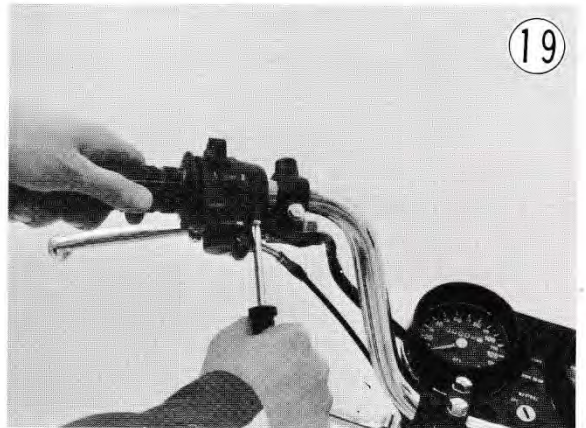

### CLUTCH LEVER

Position the clutch lever so that it is reached easily while riding, and tighten the clamp bolt securely.





## 8 ASSEMBLY

### WIRING STRAPS

Fit the wiring straps to the wiring harness on the handlebar, making sure that the wiring is not stretched or kinked.

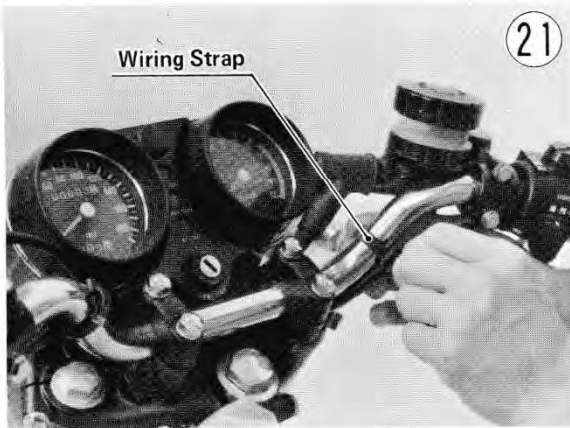

### CLUTCH CABLE

Remove the clip and flat washer from the rear of the link lever, and pull out the link pin. Remove the link lever clamp bolt, and pull the link lever off the shift shaft. Alternative way of removing the link lever is to remove the footpeg mounting bolt and remove the link lever with the shift pedal and left footpeg.

Remove the screws and take off the engine sprocket cover.

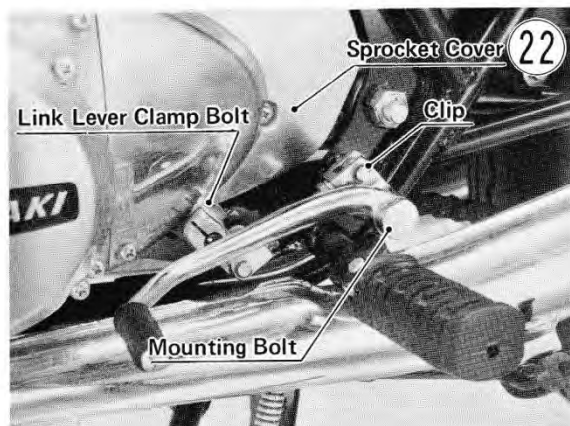

Loosen the clutch release lever lock nut, and back out the adjusting screw a couple of turns. This will give the clutch cable plenty of play.

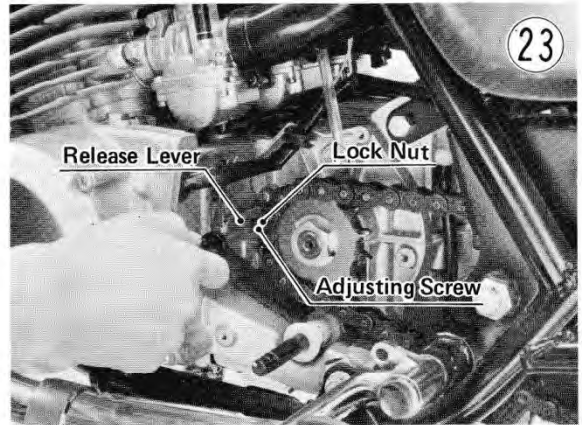

Line up the slots on the clutch lever, lock nut, and adjuster. Fit the upper end of the clutch cable into the lever, slide the cable through the slots, and release the outer cable into the adjuster.

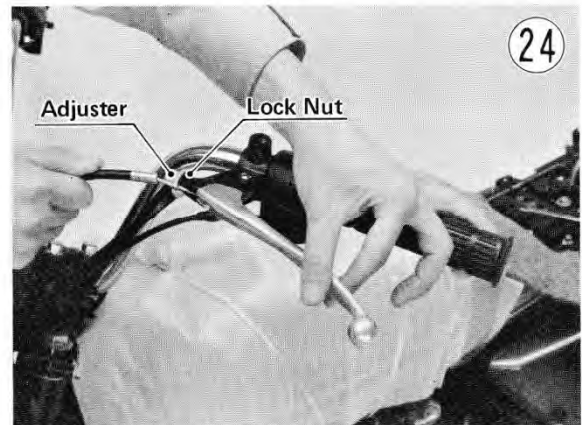

### REAR VIEW MIRROR

Mount the rear view mirror by threading it in all the way, then backing out to the proper position, and tighten the lock nut securely.





**REAR FENDER**

Slide the rear fender in place. The front edge of the fender should go between the plastic fender and large flat washer. Then hold the rear of the fender to the frame by inserting the two bolts loosely, each with a flat washer and lock washer.

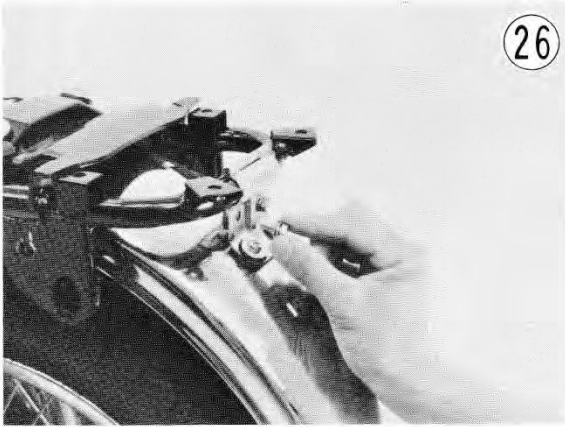

Loosen the upper shock absorber mounting nuts on both sides. Slip the slotted ends of the grab rail between the large washers on the upper shock absorbers, so that each grab rail lug is aligned with the small hole in the bracket. Do not tighten the nuts yet.

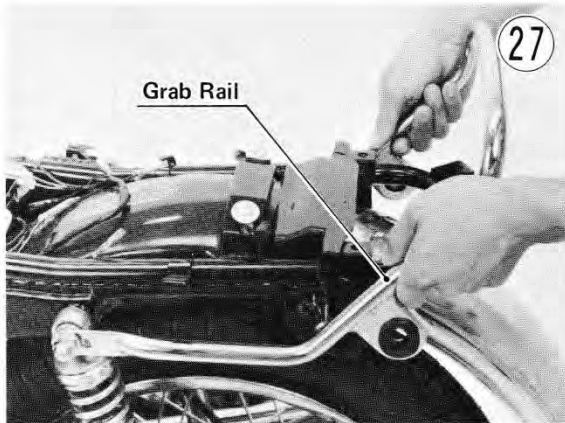

Insert the two bolts with flat washers and lock washers into the rear fender and grab rail lugs. Use the collar between the right side bracket and the fender. Tighten all the rear fender mounting bolts securely.

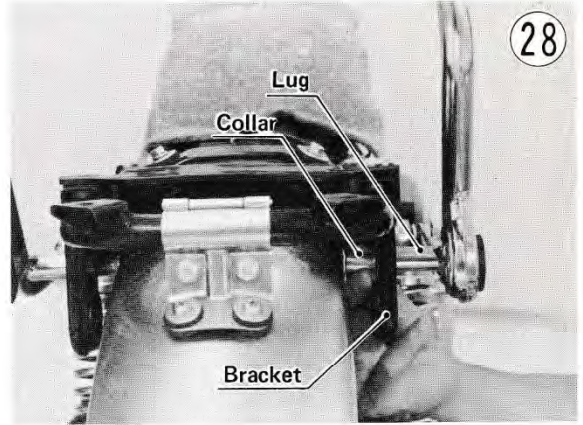

Tighten the upper shock absorber mounting nuts with 2.6 ~ 3.5 kg-m (19 ~ 25 ft-lbs) of torque.

**REAR TURN SIGNALS**

Slip the rear turn signals into place and fasten them each with a ground wire, flat washer, lock washer, and nut, as shown. Be sure that each turn signal faces rearward and ground wire is pointing to the grab rail lug, and tighten the nuts securely.

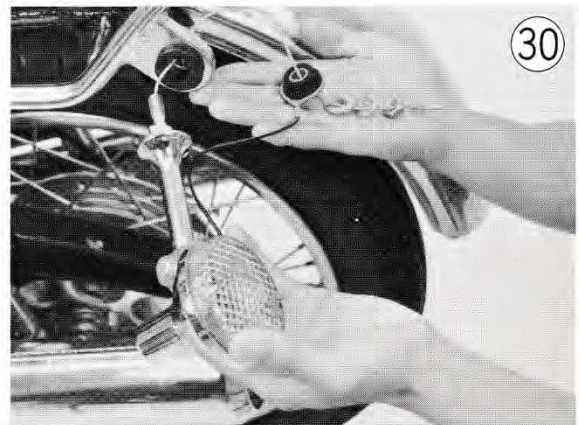



## 10 ASSEMBLY

Connect the turn signal wires according to the color codes as follows:

- Gray wire from right turn signal to Gray
- Gray wire from left turn signal to Green
- Black/Yellow wires from both turn signals to Black/Yellow

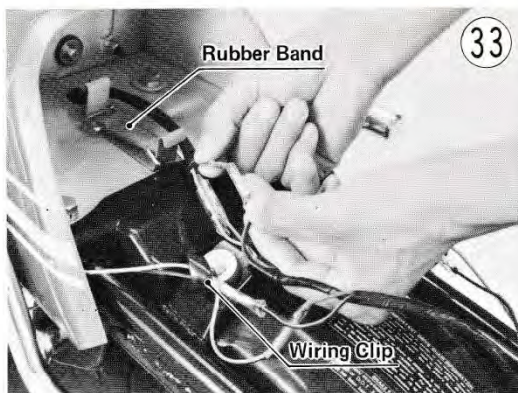
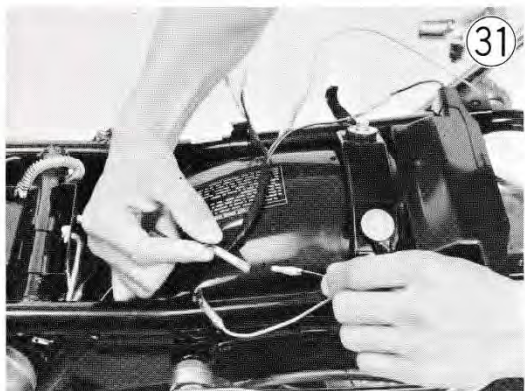

### SEAT

Attach the seat by inserting two link pins into the hinges, and insert a safety clip into each pin. Also, install a safety clip into the seat stopper.

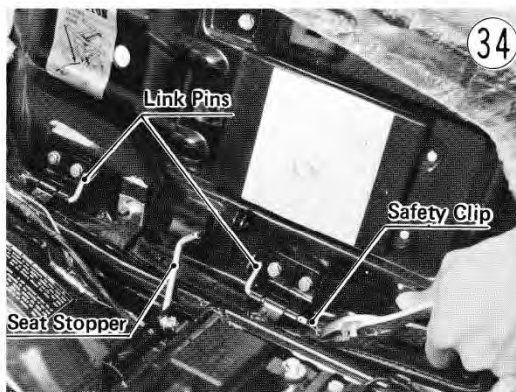

### SEAT BACK REST

Install the seat back rest by pulling it to the rear and holding it with four bolts. Each bolt should have a lock washer and flat washer.

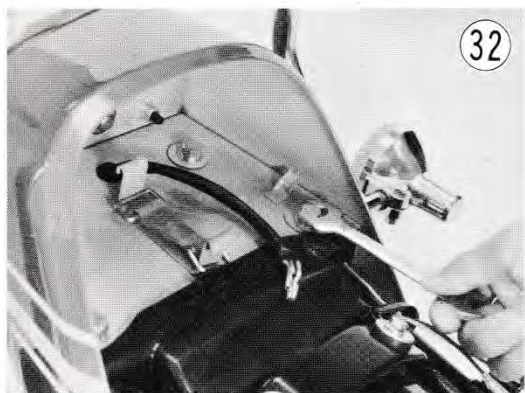

### ASSEMBLY COMPLETE

Remove all the protective coverings from the motorcycle.



Connect the taillight wires according to the color codes.

- Red to Red
- Blue to Blue/Red
- Black/Yellow to Black/Yellow

Secure the turn signal wires and taillight wires with the wiring clips, and attach the tool kit with the rubber band in the seat back rest.



# PREPARATION

## BATTERY SERVICE

Lift the seat and remove the battery from the motorcycle. Cut the plugged end of the battery vent hose or remove the rubber band. Fill the battery to the upper level line with fresh electrolyte at a temperature of 30°C (86°F) or less. Let the battery stand for 30 minutes before charging. If the electrolyte level drops below the level, refill the battery with more electrolyte before charging.

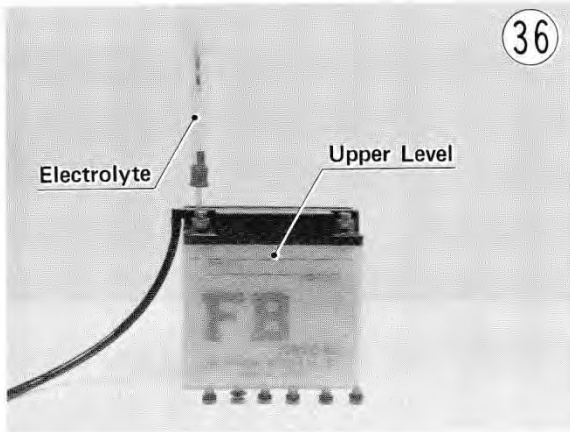

An initial charging is necessary before placing the battery in service. Connect the battery charger leads (red to +, black to -) to the battery posts. Remove the battery caps. Charge for 10 hours at no more than 0.6 amps. Stop charging if the electrolyte temperature rises above 45°C (113°F). If the fluid level drops, refill the battery with distilled water only. Wash off any spilled acid with fresh water.

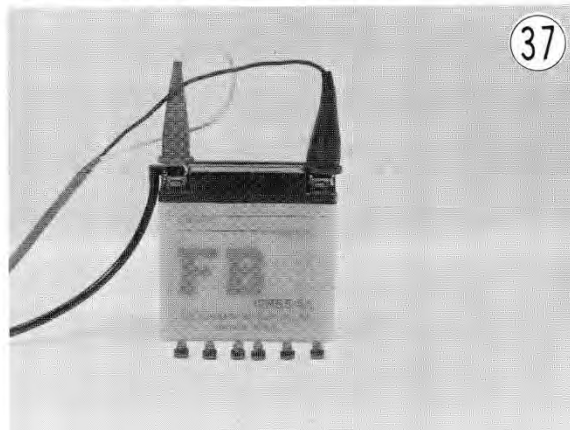

Make sure the battery mat is in place and drop the battery into place with the vent hose. Route the battery vent hose according to the CAUTION LABEL under the seat. Connect the white and

red leads to the positive terminal, and the black lead to the ground terminal.

**NOTE:** Make sure the battery vent hose end is kept away from the chain, as electrolyte from the battery vent hose will corrode and dangerously weaken the chain. Do not let the battery vent hose get folded or pinched, and route it away from the exhaust system.



## TRANSMISSION OIL

Remove the drain plug and drain the shipping oil from the transmission. After draining the transmission oil, replace the drain plug and tighten it securely.

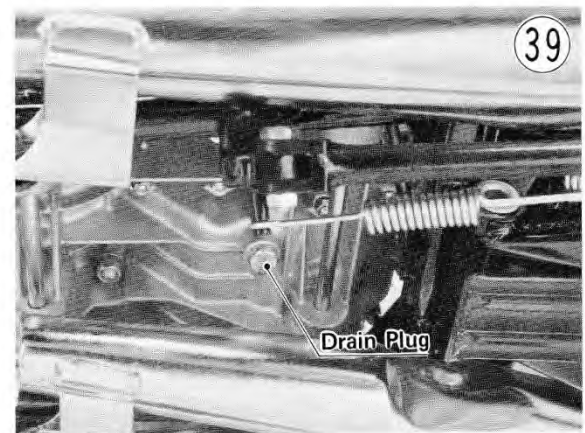

Remove the dipstick, and wipe off any oil on the end. Fill the transmission with 1.1 liters (1.0 Imp qt) of SAE 10W30 or 10W40 motor oil marked SD or SE.

Stand the motorcycle vertically and check the oil level with the dipstick. The oil should reach between the marks.

**NOTE:** The dipstick should be screwed all the way into the engine cover to check the oil level.



## 12 PREPARATION

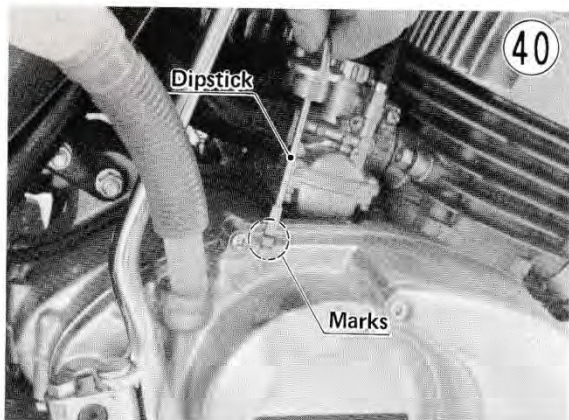

### ENGINE OIL

Check that the oil tank outlet hose is securely fastened, and fill the tank with a good quality two stroke engine oil.

**CAUTION:** Make sure the oil tank vent hose is not pinched shut, which could cause major engine damage.

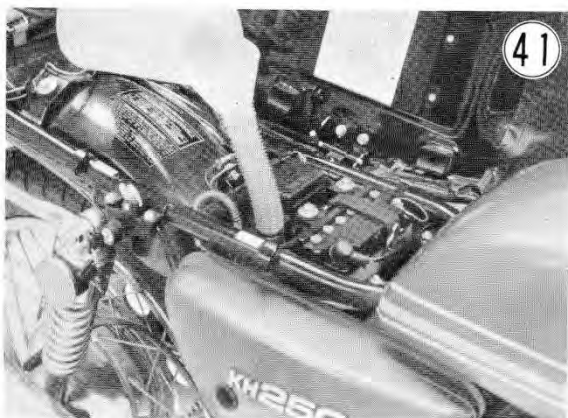

### FUEL TAP

Remove the fuel tap sediment cup and filter. Clean any foreign matter out of the cup and filter, and reassemble the fuel tap.

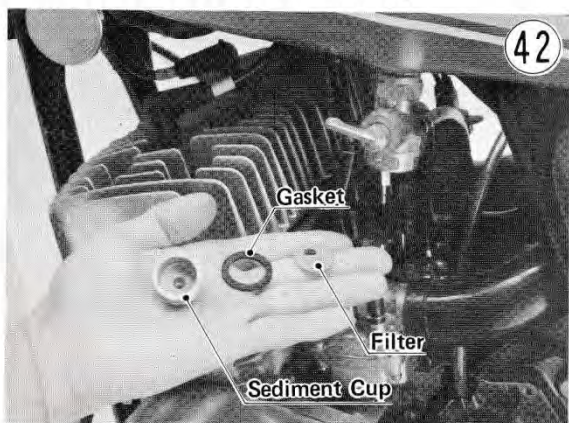

### OIL PUMP ADJUSTMENT

Remove the oil pump cover. Loosen the oil inlet banjo bolt and allow the oil to bleed out for about two minutes. This will remove any air bubbles in the hose from the oil tank. Tighten the oil inlet banjo bolt securely, and see that the outlet banjo bolts are also tight.

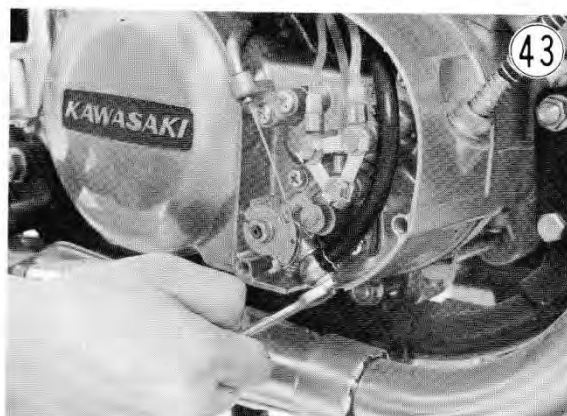

Start the engine and hold it at a steady speed of about 1,500 to 2,000 rpm. Push the oil pump lever to the full open position to bleed any air bubbles out of the oil pump body and the oil pressure line. When the exhaust smokes heavily, release the lever and stop the engine.

**CAUTION:** If the exhaust does not smoke, check for blockage or loose connections.

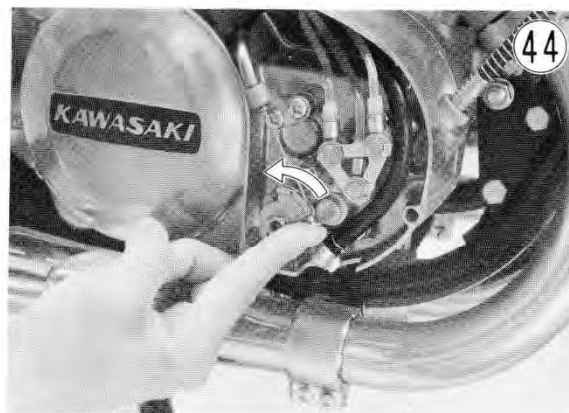

Only after adjusting the carburetor, adjust the oil pump. The mark on the oil pump lever should align with the mark on the oil pump body. If it does not, loosen the lock nut and turn the



adjuster as required. Tighten the lock nut securely. Replace the oil pump cover.

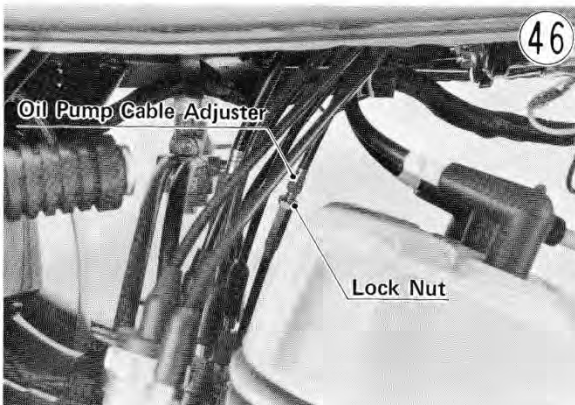
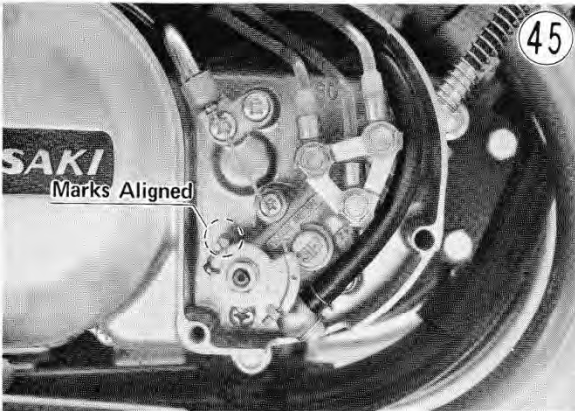

**IGNITION TIMING**  
**Point Gap Adjustment**

Turn off the ignition switch and the engine stop switch to one of the OFF position. Remove the point cover.

Turn the crankshaft so that the contact breaker points are at their widest opening. If the gap is not 0.3~0.4 mm (0.012~0.016 inch), loosen the base screw and use a screwdriver in the pry points to set the gap to 0.35 mm (0.014 inch). Tighten the screw securely after adjustment.

Turn the crankshaft until the other set of points is opened, and adjust them.

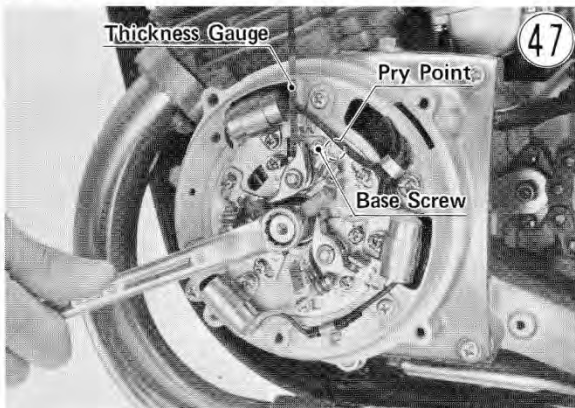

**Ignition Timing Adjustment**

1. Remove the left spark plug, and insert a dial gauge.
2. Timing marks L, C, and R engraved in the rotor face can be seen by looking through the inspection window in the stator.
3. Using a timing tester, check the ignition timing. If ignition timing is correct, the points are just beginning to open when the rotor and stator marks are aligned.
4. To adjust the timing, loosen two screws, insert a screwdriver between the pry points, and turn the screwdriver to move the stator plate back and forth so that the timing is correctly set.
5. This adjustment must be done for each of the three sets of points to completely set ignition timing.
6. When the L marks are aligned, for example, the L stator plate mounting screws should be loosened and plate L pried, etc.
7. When correctly set, timing is 23° BTDC, which in terms of piston position means the piston is 2.60 mm (0.1024 in) from Top Dead Center.
8. Remove the dial gauge, and replace the left spark plug.

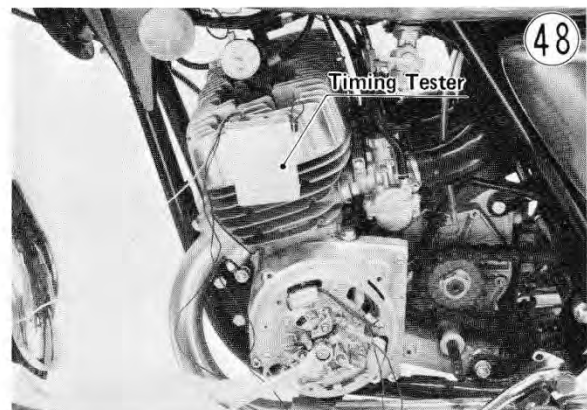

**Ignition Timing Inspection (Dynamic)**

1. Connect the strobe light lead to the left spark plug lead.
2. Start the engine with the idling. Check to see that the mark on the stator aligns with the "L" mark on the rotor.
3. Repeat the procedure for the center and right hand cylinder points, using the "C" and "R" marks, respectively.
4. If it does not align, loosen the mounting screw of the adjusting plate, and move the adjusting plate with a screw driver inserted in the pry point.
5. Recheck the timing with strobe light.
6. Replace the point cover.



## 14 PREPARATION

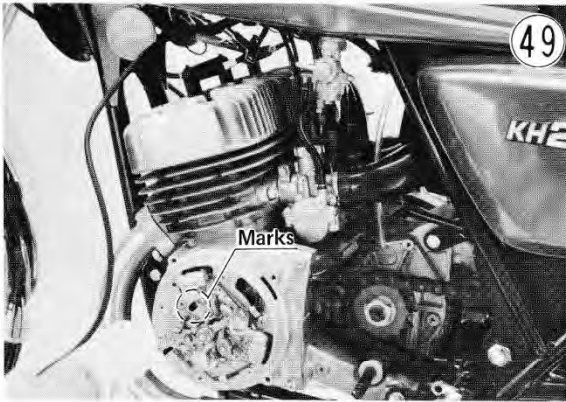

### IDLING ADJUSTMENT

Turn in the air screw of each carburetor fully (but not tightly), and then back it out 1½ turns.

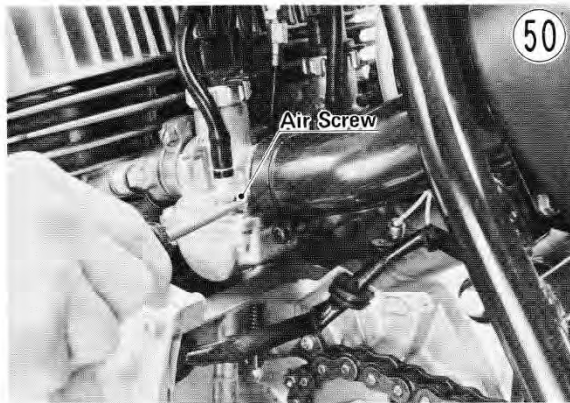

Start the engine and warm it up for 5 minutes, and then adjust engine idle with the each idling screw so that idle rpm is about 1,200 ~ 1,300 rpm by the tachometer.



### CLUTCH ADJUSTMENT

1. Loosen the lock nut at the clutch lever just enough so that the adjuster will turn freely, and then turn the adjuster to make a 5 ~ 6 mm (0.20 ~ 0.24 inch) gap between the adjuster and lock nut.

2. Loosen the lock nut at the lower end of the clutch cable.
3. Loosen the clutch release lever lock nut, and back out the clutch adjusting screw 3 ~ 4 turns.
4. Set the clutch release lever angle at about 80° to the clutch cable by turning the adjusting nut at the middle of the clutch cable.
5. Turn the clutch adjusting screw into where it suddenly becomes hard to turn, and then tighten the lock nut.
6. Replace the engine sprocket cover.

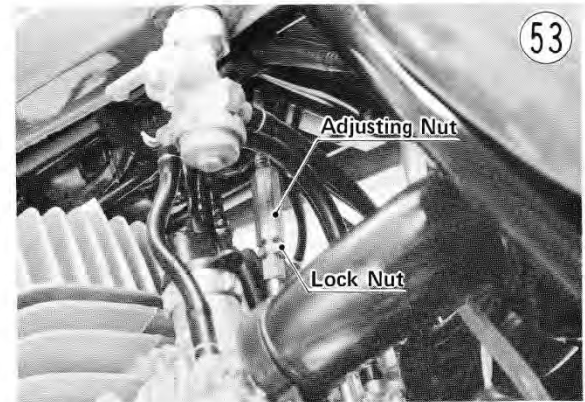
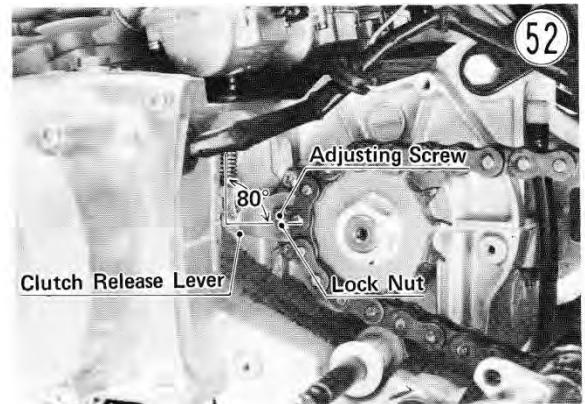

Turn the adjuster at the clutch lever until the clutch lever has 2 ~ 3 mm (1/16 ~ 1/8 inch) of play and tighten the lock nut.

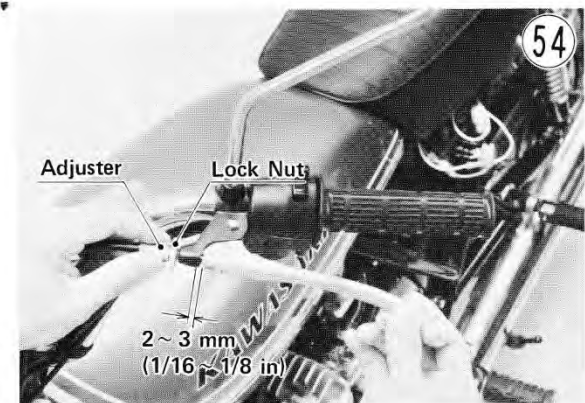



**DRIVE CHAIN ADJUSTMENT**

With the unit on the center stand, the drive chain should have 20~25 mm ( $\frac{3}{4}$ ~1 inch) of up and down play in the lower run. If it does not, loosen the brake adjusting nut, the torque link nut, the axle nut, and the lock nuts on both of the adjusters, and turn the chain adjusting bolts as required. To help keep the sprocket and rear wheel properly aligned, there are marks on the swing arm tabs. Be sure the alignment marks on the chain adjusters are on equal marks on both tabs. Tighten the lock nuts and the axle nut securely.

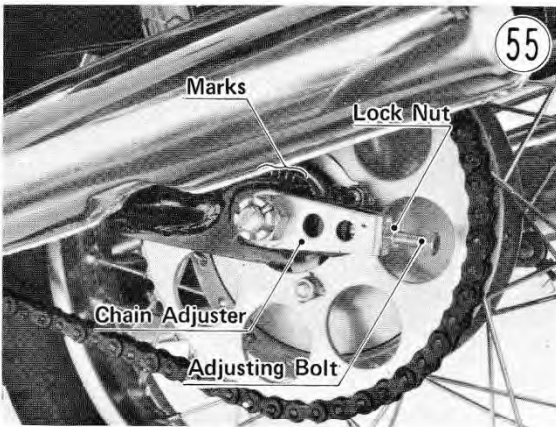

**REAR BRAKE ADJUSTMENT**

Check that the top of the brake pedal in its rest position is about 20 ~ 30 mm ( $\frac{3}{4}$  ~ 1 $\frac{1}{4}$  inch) lower than the upper surface of the footpeg.

To adjust pedal position, loosen the lock nut, turn the adjusting bolt, and tighten the lock nut.

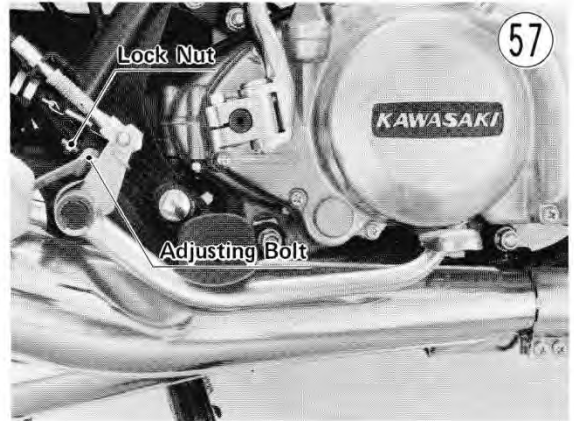

Turn the adjusting nut at the end of the brake cable so that the brake pedal has about 20~30 mm ( $\frac{3}{4}$ ~1 $\frac{1}{4}$  inch) of travel from the rest position to the fully applied position when the pedal is pushed down lightly by hand.

**FRONT BRAKE FLUID CHECK**

Check the fluid in the brake master cylinder reservoir with the reservoir held as nearly level as possible. If the fluid is below the lower edge of the lid, fill it with the brake fluid marked "D,O,T,3" only. Check the Owner's Manual for recommended brands.

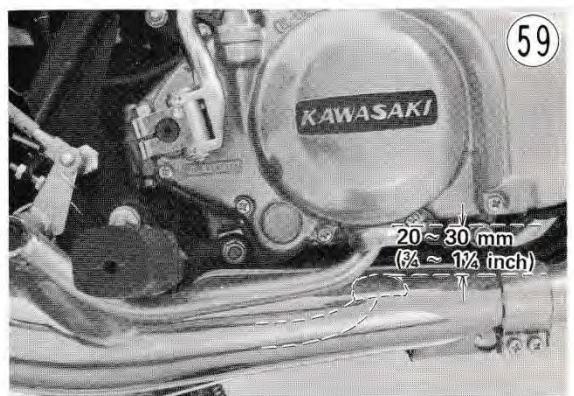
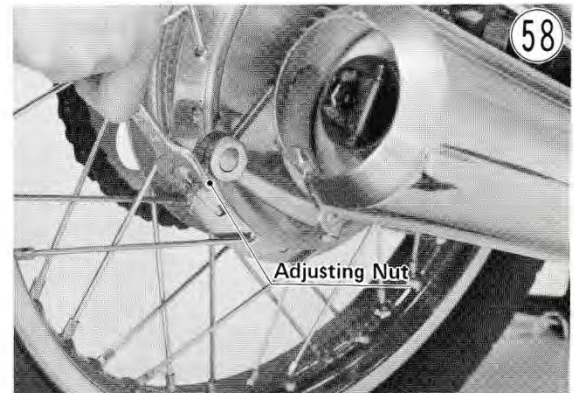
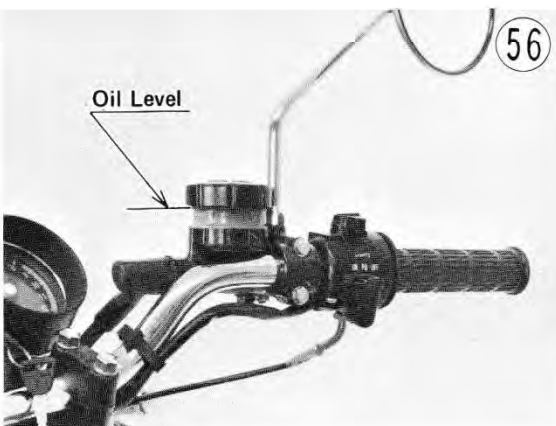



## 16 PREPARATION

Turn on the ignition switch. The brake light should light when the brake pedal is depressed about 15 mm (5/8 inch). If it does not, loosen the mounting nuts and turn the nuts as required. Tighten the mounting nuts after adjustment securely. Although it requires no adjustment, test the front brake light switch at this time.



## TIRE PRESSURES

To prevent flat-spotting during shipment, the tires are over-inflated before crating. Adjust the pressures to 1.75 kg/cm<sup>2</sup> (25 psi) in the front and 2.0 kg/cm<sup>2</sup> (28 psi) in the rear.

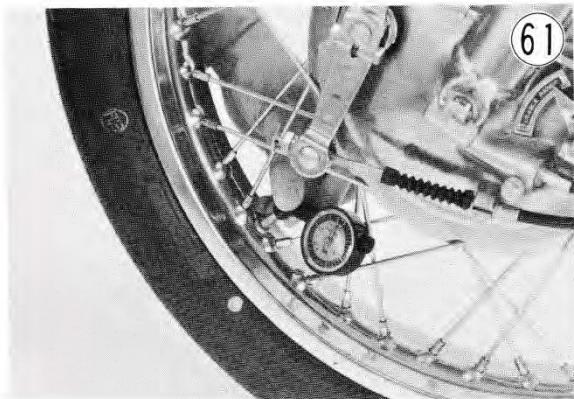



# Appendix

## SPECIFICATIONS

### ENGINE

|                     |  |             |
|---------------------|--|-------------|
| Type                | 2-stroke, 3 cylinder, piston valve         |             |
| Bore and stroke     | 45.0 x 52.3 mm (1.77 x 2.06 inch)          |             |
| Displacement        | 249 cc (15.19 cu in)                       |             |
| Compression ratio   | 7.5 : 1                                    |             |
| Maximum horsepower  | 26 HP/6,000 rpm                            |             |
| Maximum torque      | 2.7 kg-m/6,500 rpm (19.5 ft-lbs/6,500 rpm) |             |
| Port (Valve) timing |  |             |
| Intake              | Open                                       | 76°30' BTDC |
|                     | Close                                      | 76°30' ATDC |
| Scavenging          | Open                                       | 60° BBDC    |
|                     | Close                                      | 60° ABDC    |
| Exhaust             | Open                                       | 83° BBDC    |
|                     | Close                                      | 83° ABDC    |
| Lubrication system  | Superlube (oil injection)                  |             |
| Starting system     | Kick                                       |             |
| Ignition system     | Battery and coil                           |             |
| Ignition timing     | 23° BTDC                                   |             |
| Spark plugs         | NGK B9HS                                   |             |

### CARBURETOR

|                   |  |
|-------------------|--|
| Manufacture, Size | Mikuni VM22SC                                    |
| Main jet          | 75-R * 67.5-R                                    |
| Jet needle        | 4EJ9-3   |
| Needle jet        | O-2  |
| Throttle valve    | 2.5  |
| Pilot jet         | 20   |
| Air screw         | 1½   |
| Fuel level        | 3 ~ 5 mm (below the edge of the carburetor body) |
| Identification    | S1U-1 * S1E-1                                    |

### LUBRICATION

|                           |                                     |
|---------------------------|-------------------------------------|
| Engine oil type           | 2-stroke engine oil                 |
| Engine oil quantity       | 1.5 liters (1.3 Imp qt)             |
| Transmission oil type     | SAE 10W30 or 10W40                  |
| Transmission oil quantity | 1.1 liters (1.0 Imp qt)             |
| Front fork oil type       | SAE 10W                             |
| Front fork oil quantity   | 206 ~ 214 cc (5.80 ~ 6.03 Imp H oz) |
| Front fork oil level      | 365 mm (14.4 inch)                  |
| Chain oil                 | SAE 90                              |

\* Europe, Australia Models

Specifications subject to change without notice.



## 18 APPENDIX

### CHECK AND TIGHTEN

Check the tightness of the bolts and nuts shown below, and retighten if required. Also, check the (☆) marked items whether or not a cotter pin or safety clip is used.

Dealer is requested to retighten the asterisk (\*) marked points with specified torque, and apply yellow paint to assure your customer that the motorcycle is prepared for use with great care.

| ITEM | DESCRIPTION                        | TOOL SIZE | REMARKS                             |
|------|------------------------------------|-----------|-------------------------------------|
| 1    | Rear Shock Absorber Bolts (2)      | 14 mm     | 2.6 ~ 3.5 kg-m (19.0 ~ 25 ft-lbs)   |
| 2    | Kick Starter Pedal Bolt            | 14 mm     |                                     |
| 3    | Engine Bracket Bolts               | 14 mm     |                                     |
| 4    | Cylinder Head Nuts (12)            | 17 mm     | 2.0 ~ 2.4 kg-m (14.5 ~ 17.5 ft-lbs) |
| 5    | * Steering Stem Nut                |           | 2.7 ~ 3.3 kg-m (19.5 ~ 24 ft-lbs)   |
| 6    | Steering Stem Head Bolt            |           |                                     |
| 7    | * Brake Hose Banjo Bolt            | 14 mm     | 2.9 ~ 3.1 kg-m (21 ~ 22 ft-lbs)     |
| 8    | * Handlebar Clamp Bolts (4)        | 13 mm     | 1.6 ~ 2.2 kg-m (11.5 ~ 16.0 ft-lbs) |
| 9    | * Brake Hose Banjo Bolts (2)       | 14 mm     | 2.9 ~ 3.1 kg-m (21 ~ 22 ft-lbs)     |
| 10   | Rear Brake Cam Lever Bolt          | 10 mm     |                                     |
| 11   | Tire Pressure — Rear               |           | 2.0 kg/cm <sup>2</sup> (28 psi)     |
| 12   | ☆ Torque Link Nuts (2)             | 14 mm     | 2.6 ~ 3.5 kg-m (19.0 ~ 25 ft-lbs)   |
| 13   | ☆ Brake Pedal Pivot                |           |                                     |
| 14   | ☆ Footpeg Pivot (2)                |           |                                     |
| 15   | Footpeg Mounting Bolts (2)         | 17 mm     |                                     |
| 16   | Engine Mounting Nuts (3)           | 14 mm     | 2.6 ~ 3.5 kg-m (19.0 ~ 25 ft-lbs)   |
| 17   | Exhaust Pipe Holder Nuts (6)       | 12 mm     |                                     |
| 18   | * Front Axle Clamp Nuts (4)        | 13 mm     | 1.6 ~ 2.2 kg-m (11.5 ~ 16.0 ft-lbs) |
| 19   | Tire Pressure — Front              |           | 1.75 kg/cm <sup>2</sup> (25 psi)    |
| 20   | * Bleed Valve                      | 10 mm     | 0.7 ~ 1.0 kg-m (61 ~ 87 in-lbs)     |
| 21   | * Brake Pipe Banjo Bolts (2)       | 10 mm     | 1.7 ~ 1.9 kg-m (12.0 ~ 13.5 ft-lbs) |
| 22   | * Front Brake Light Switch         |           | 2.6 ~ 3.0 kg-m (19.0 ~ 22 ft-lbs)   |
| 23   | Lever Pivot Nuts (2)               | 8 mm      |                                     |
| 24   | * Front Fork Upper Clamp Bolts (2) | 13 mm     | 1.6 ~ 2.2 kg-m (11.5 ~ 16.5 ft-lbs) |
| 25   | * Steering Stem Head Clamp Bolt    | 13 mm     | 1.6 ~ 2.2 kg-m (11.5 ~ 16.5 ft-lbs) |
| 26   | Fuel Tap Nut                       | 26 mm     |                                     |
| 27   | Swing Arm Pivot Nut                | 22 mm     | 6 ~ 10 kg-m (43 ~ 72 ft-lbs)        |
| 28   | Rear Shock Absorber Nuts (2)       | 17 mm     | 2.6 ~ 3.5 kg-m (19.0 ~ 25 ft-lbs)   |
| 29   | ☆ Rear Axle Nut                    | 27 mm     | 10 ~ 14 kg-m (72 ~ 101 ft-lbs)      |
| 30   | Caliper Bolts (2)                  | 14 mm     |                                     |
| 31   | Front Axle Nut                     | 27 mm     | 7 ~ 9 kg-m (51 ~ 65 ft-lbs)         |
| 32   | Caliper Bracket Bolts (2)          | 14 mm     | 3.4 ~ 4.6 kg-m (25 ~ 33 ft-lbs)     |
| 33   | Front Fork Lower Clamp Bolts (2)   | 14 mm     |                                     |
| 34   | ☆ Handlebar Holder Clamp Nuts (2)  | 14 mm     |                                     |
| 35   | Engine Mounting Bracket Nuts (4)   | 13 mm     | 1.6 ~ 2.2 kg-m (11.5 ~ 16.5 ft-lbs) |
| 36   | Shift Pedal Link Lever Bolt        | 13 mm     |                                     |
| 37   | Footpeg Mounting Bolts (2)         | 21 mm     |                                     |
| 38   | Rear Sprocket Nuts (4)             | 14 mm     |                                     |
| 39   | Spoke Nipples                      |           | 0.2 ~ 0.4 kg-m (17 ~ 35 in-lbs)     |



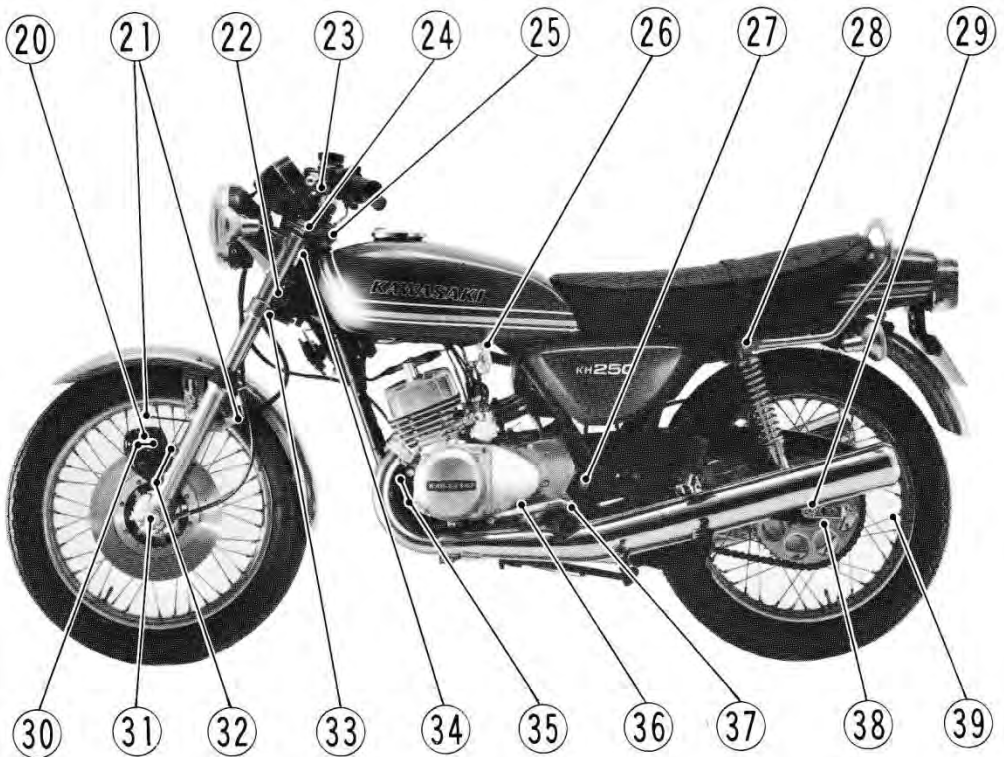
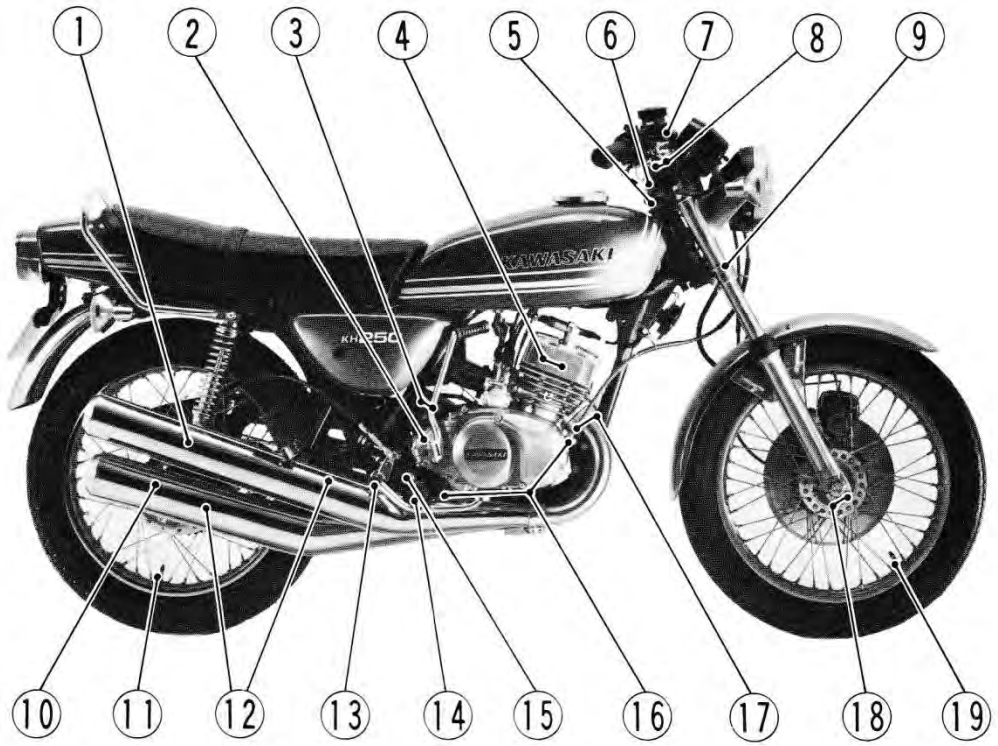



## 20 APPENDIX

The table below, relating tightening torque to thread diameter and pitch, lists the basic torque for the bolts and nuts used on Kawasaki Motorcycles. However, the actual torque that is necessary may vary among bolts and nuts with the same thread diameter and pitch. The bolts and nuts listed on Pg. 18 vary to a greater or lesser extent from what is given in this table. Refer to this table for only the bolts and nuts not included in the table on Pg. 18. All of these values are for use with dry solvent cleaned threads.

### Coarse threads

| dia (mm) | pitch (mm) | kg-m      | ft-lbs    |
|----------|------------|-----------|-----------|
| 5        | 0.90       | 0.35~0.50 | 2.5~3.5   |
| 6        | 1.00       | 0.6~0.9   | 4.5~6.5   |
| 8        | 1.25       | 1.6~2.2   | 11.5~16.0 |
| 10       | 1.50       | 3.1~4.2   | 22~30     |
| 12       | 1.75       | 5.4~7.5   | 39~54     |
| 14       | 2.00       | 8.3~11.5  | 60~83     |
| 16       | 2.00       | 13~18     | 94~130    |
| 18       | 2.50       | 18~25     | 130~181   |
| 20       | 2.50       | 26~35     | 188~253   |

### Fine threads

| dia (mm) | pitch (mm) | kg-m      | ft-lbs    |
|----------|------------|-----------|-----------|
| 5        | 0.50       | 0.35~0.50 | 2.5~3.5   |
| 6        | 0.75       | 0.6~0.8   | 4.5~5.5   |
| 8        | 1.00       | 1.4~1.9   | 10.0~13.5 |
| 10       | 1.25       | 2.6~3.5   | 19.0~25   |
| 12       | 1.50       | 4.5~6.2   | 33~45     |
| 14       | 1.50       | 7.4~10.2  | 54~74     |
| 16       | 1.50       | 11.5~16   | 83~116    |
| 18       | 1.50       | 17~23     | 123~166   |
| 20       | 1.50       | 23~33     | 166~239   |



**TEST RIDE THE MOTORCYCLE**

- **CONTROL CABLES**  
The control cables must work without binding in any steering position.
- **STEERING**  
Action is free from lock-to-lock.
- **SUSPENSION**  
Check operation front and rear.
- **ENGINE**  
Kickstarter works properly and engine starts promptly.  
Good throttle response and return.
- **TRANSMISSION AND CLUTCH**  
Smooth operation.
- **BRAKES**  
Adequate, smooth stopping power. No drags.
- **SPEEDOMETER AND TACHOMETER**  
Check operation.
- **ELECTRICAL SYSTEM**  
Headlight – check high and low beams.  
Tail Light – check operation.  
Brake Light – check operation.  
Turn Signal Light – check operation.  
Horn – check operation.
- **ENGINE STOP SWITCH WORKS**
- **NO UNUSUAL NOISES**
- **NO FUEL OR OIL LEAKS**



# 22 APPENDIX

## WIRING DIAGRAM (US Model)

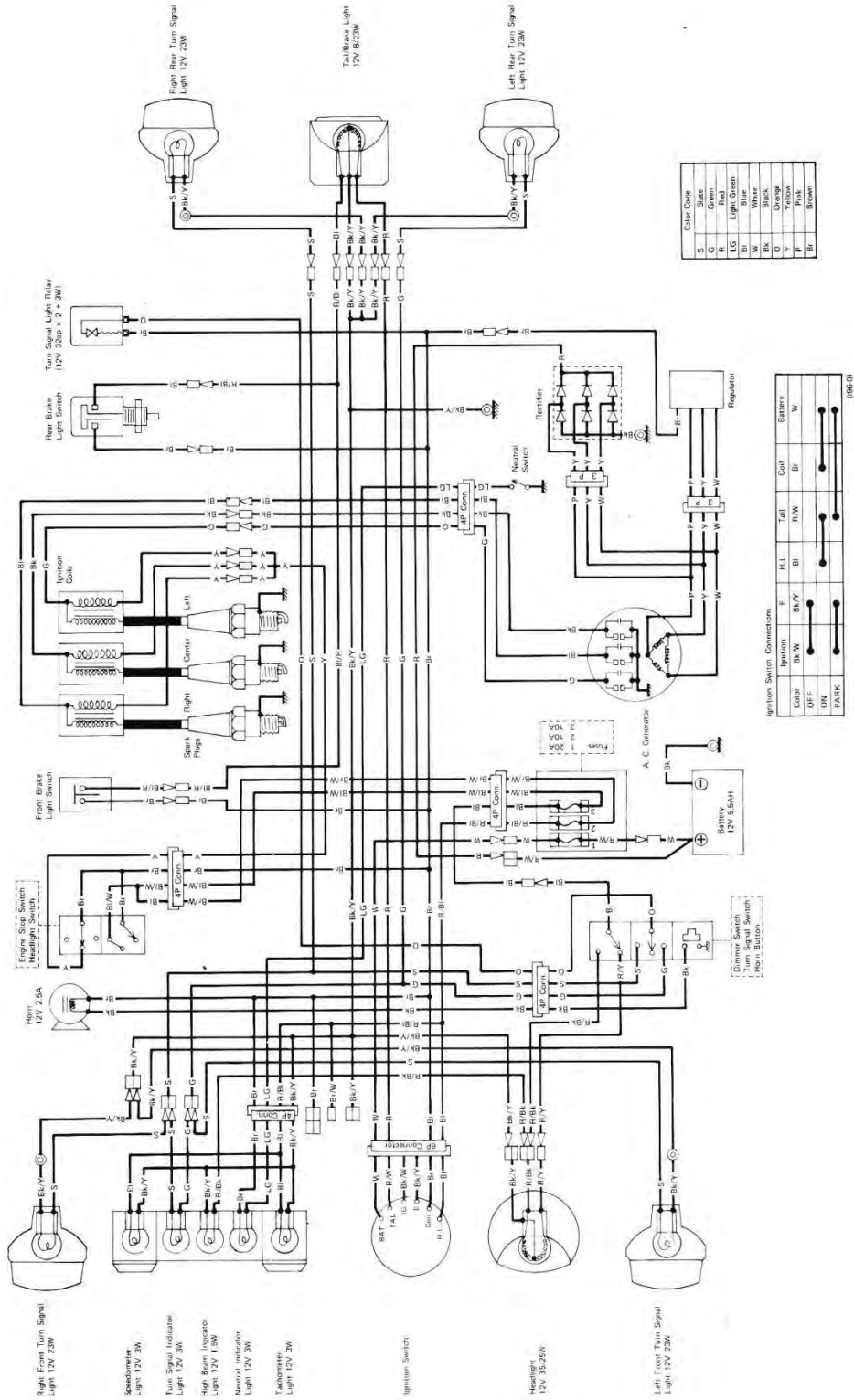



WIRING DIAGRAM (European Model)

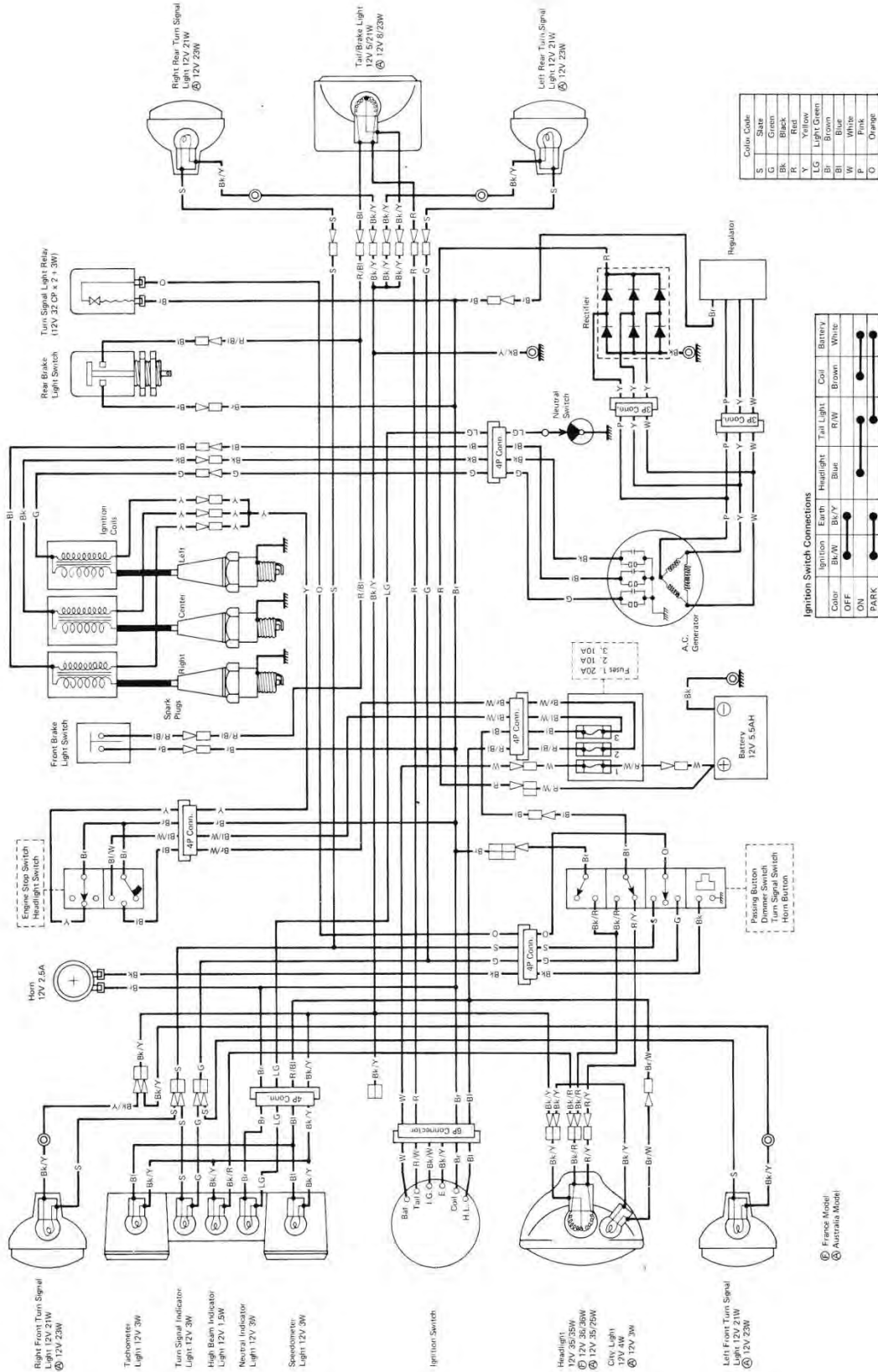

Ⓜ France Model  
Ⓜ Australia Model

(236-0)  
(237-0)

MEMO









**KAWASAKI**  
HEAVY INDUSTRIES, LTD.  
ENGINE AND MOTORCYCLE GROUP

Part No. 99931-506-01

Printed in Japan